

SIEMENS

Gigaset
3010
Classic



Operating Instructions

and Safety precautions 

General

Safety precautions

- Only use the **plug-type AC adapter supplied** as indicated on the underside of the unit.
- Never use ordinary (non-rechargeable) batteries. Only use **approved batteries of the same type** (rechargeable), as otherwise battery damage can result (dangerous), see the table on page 10.
- Medical equipment can be affected by the handset.
- The handset can cause an unpleasant humming sound in hearing aids.
- Do not install the base station in bathrooms or showers.
- Do not operate the telephone in environments where there is risk of explosion (e.g. paint shops).
- Dispose of batteries and the telephone in an environmentally friendly manner in accordance with the relevant legislation.
- Ensure that the operating instructions are included when passing on your Gigaset to a third party.

The handset's battery compartments feature the following diagrams:

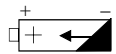



















Insert rechargeable batteries correctly in accordance with polarity symbols.



Operate battery type in accordance with these operating instruction.

Displays



	Base station icon		Pause
	Charging status icon		System code
	Mailbox function: New number in the caller list		Blank
	Off hook		Star key 
	External connection		Hash key 
	Internal connection		Recall key 
	handset locked		Telephone PIN input
			Keypad protection

Gigaset 3000 Classic handset: brief overview

Base station icon

- **Constant:** ready for dialling/to receive
- **Flashing:** no base station contact

Charging status

-  full
-  empty

Redial a number

Speed dialling

Activate

Set key

- To save
- For settings

End call key

- End call
- **Handset on/off:** hold key down
- Cancel function

Recall key

- For systems & select services
- **Pause:** hold key down

Make internal call

Talk key

- accept call
- dial call number

Keypad protection

on/off:
hold key down

Delete characters



Display keys



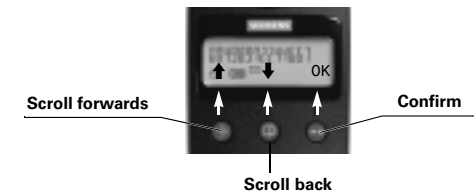















































When icons are displayed above the 3 keys in the display, the meaning of these icons is as follows:



General

Quick reference guide

For information on handset settings, see overview on cover.

Function	Key combination
Activate/deactivate the handset	Hold down  for 1 second
Activate/deactivate keypad protection	Hold down  for 1 second
Answer a call	
Make an external call	 
Redial a number	 or  
Save a speed dial number	  e.g.     
Dial a speed dial number	  or e.g.  
Dial a number from call list	   
Set handset volume	    e.g.  
Mute microphone	 Microphone muted ;  Microphone on
Make an internal call	 e.g. 
Call all handsets	 
Transfer call (connect)	 e.g.  
Internal enquiry call	 e.g.  ; terminate enquiry call: 
Set date	    set the date 
Set time	    Set the time 

Contents

General	2
Safety precautions	2
Displays	2
Gigaset 3000 Classic handset: brief overview	3
Quick reference guide	4
Preparing the telephone	7
Checking the package contents	7
Installing/connecting the base station	7
Inserting/charging the batteries	9
Attaching the belt clip	11
Activating/deactivating the handset	11
Activating/deactivating keypad protection	11
Making calls	12
Making an external call	12
Making an internal call	12
Answering a call	13
Displaying the incoming call number (CLIP)	13
Muting the microphone	13
Paging	13
Enhanced telephone features	14
Redial	14
Speed dialling	14
Caller list/mailbox function	16
Cost-effective telephoning	17
Network access support	17
Displaying the call duration	17
Individual handset settings	18
Setting the ringer volume	18
Setting the ring melody	18
Setting the handset volume	18
Activating/deactivating beeps	18
Activating/deactivating base station display	19
Auto talk	19
Resetting the handset to factory default	20
Registering at more than one base station	20
Changing the base station	20
Base station settings	21
Setting the date/time	21
Setting the ringer volume	22
Setting the ring melody	22
Activating/deactivating music on hold	22

Contents

Setting pauses	23
Resetting the factory settings	24
Handset security	25
Changing the telephone PIN	25
Activating the telephone lock	25
Dialling an emergency number	26
Deactivating the telephone lock	26
Base station security	27
Changing the base station's system PIN	27
Activating/deactivating the base lock	27
Barring/enabling call numbers	28
Saving emergency numbers	29
Operating more than one handset	30
Registering additional handsets	30
Making an internal call	31
Forwarding a call	31
Internal enquiry call	32
Accepting call waiting	32
Collective call	32
Displaying the handset number	32
Open listening at the handset	33
De-registering handsets	33
Disabling external dialling from individual handsets	34
Connecting a fax/modem	34
Activating/deactivating the ringer	35
Setting ring delay/collective call	35
Connecting to a PABX	37
Setting the dialling mode	37
Switching to tone dialling	37
Saving a dial-out code	38
Pause after dial-out code	38
Appendix	39
Maintenance	39
Troubleshooting	39
Guarantee/service/approval	40
Index	41
Settings – overview	Cover

Preparing the telephone

Checking the package contents

The package contains the following:

- one Gigaset 3015 base station
- one Gigaset 3000 Classic handset
- one plug-type AC adapter
- one telephone cord
- one belt clip for the handset
- two batteries
- one set of Gigaset 3010 Classic operating instructions

Installing/connecting the base station

Notes on installation



- The base is designed for operation **in protected rooms** with a temperature range from +5°C to +45°C.
- Install the base station in a **central location** in the flat/house, e.g. in the hall.



- Do **not** install the base station **in the bathroom**.
- Do not operate the handset in environments where there is risk of explosion, such as a paint shop.

Range

The base station range is approx. 300 m outdoors and up to 50 m indoors. The base station icon indicates whether radio contact exists between the base station and handset:



Base station icon is constant:

The handset is ready for dialling and to receive calls.



Base station icon flashes:

No radio contact between the handset and the base station - dialling or calling is not possible!

Preparing the telephone

Connecting the base station



Only use the **plug-type AC adapter supplied** as indicated on the underside of the base station.

1.

- Insert **small connector on telephone cord** into  jack (clicks into place)
- Place cord in cable duct
- Insert telephone jack into telephone socket

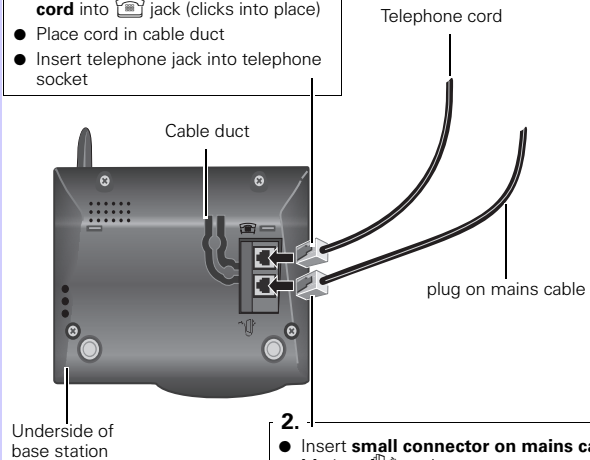

2.

- Insert **small connector on mains cable** into  socket
- Place cord in cable duct
- Insert AC adapter with plug into mains socket

Preparing the telephone

Inserting/charging the batteries



- The **handset** is already registered at the base station **when shipped**.
- For information on registering **additional handsets or replacement handsets** (after repairs), see page 30.

Inserting the batteries



- Never use ordinary (non-rechargeable) batteries. Only use **batteries that have been approved** (rechargeable), see table on page 10.
- Never use approved batteries of the same type.
- Never use non-Siemens charging units as these can damage the batteries.
- Please dispose of old, defective batteries in an environmentally-friendly manner.

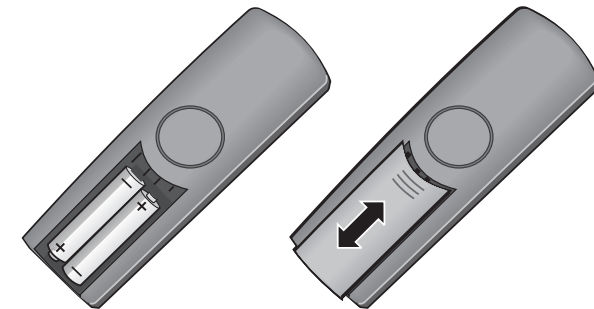





- Insert the batteries, ensuring **correct polarity** – see figure on left.
- Insert the cover approx. **3 mm into the battery compartment** and push gently **forwards** until it clicks into place.
- **To open** the cover, press the grooved area on the cover and slide **back**.

Preparing the telephone

Charging the batteries

The batteries supplied are **not charged**.

To charge the batteries, insert the handset in the base station or Gigaset 3000L charging unit (accessory) – you will hear the confirmation beep. The charging status icon flashes on the handset display to indicate that a charging operation is in progress:

- | | | | |
|---|---------------------------------|---|---------------------------------|
|  | Batteries empty |  | Batteries $\frac{2}{3}$ charged |
|  | Batteries $\frac{1}{3}$ charged |  | Batteries full |

-  – We recommend initially charging the batteries for at least 16 hours without interruption – irrespective of the status shown on the charging status icon.
- Once the first charging operation is complete, you can replace the handset in the base station after every call. Charging is controlled electronically. This ensures optimum charging and prolongs battery life.
- The batteries heat up during charging. This is normally and not dangerous.
- The battery charging status is only correctly displayed after uninterrupted charging/discharging. You should therefore avoid opening the battery compartment unnecessarily.

Approved batteries:

Nickel-cadmium (NiCd)	Nickel-metal-hydride (NiMH)
Sanyo N-3U (700 mAh)	Sanyo H-3 U (1500 mAh)
GP GP60AAKC (600 mAh)	GP GP130 AA HC (1300 mAh)
Varta 751RS (700 mAh)	GP GP150 AA HC (1500 mAh)
Mobile Power 700 (700 mAh)	Varta VH 1101 oder Phone Power (1000 mAh)
Panasonic 600 DT (600 mAh)	Panasonic HHR-110 AA (1100 mAh)
	Friwo NiMH (1400 mAh)
	Toshiba TH-1200 AARE (1200 mAh)

Handset operating time/charging time:

Capacity (mAh)	Standby time (hours)	Talktime (hours)	Charging time (hours)
700	up to 100	over 10	approx. 5
1100	up to 160	over 15	approx. 9
1500	up to 220	over 20	approx. 12

Preparing the telephone

Attaching the belt clip

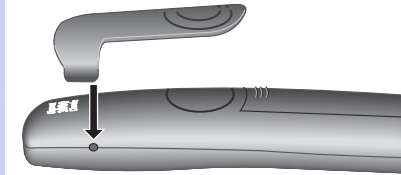

Press the belt clip onto the back of the handset until the side protrusions click into place in the holes provided.

Activating/deactivating the handset

-  Press the end call key for **1 second** – you will hear the confirmation beep*!

 The handset activates automatically as soon as you insert the batteries and place it in the base station/charging unit.

Activating/deactivating keypad protection

You can deactivate the handset keys, e.g. when carrying the unit in your pocket or bag. This protects the keypad against inadvertent activation. Calls can be accepted with the talk key .

-  To activate/deactivate keypad protection, hold the key shown for **1 second** – you will hear the confirmation beep*!

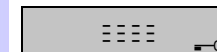

Display when keypad protection is activated.

* 1 long tone = confirmation, 4 brief tones = error

Making calls

Press keys:

Making calls

Making an external call

External calls are calls using an external line.



Enter the call number.

If necessary, correct it with the delete key .



Press the talk key to start the dial operation.





Ending a call:



Press the end call key.



- You can also **press the talk key**  **first** and then enter the call number – each digit is dialled immediately.

- You can **cancel the dial operation** with the end call key .

- You can insert a **pause** with the recall key  (hold key down).

- You can opt to **not save entries**, e.g. when controlling external telephone services: press the keys   during a call, all numbers entered afterwards are **not** saved for number redial.

- Adjust the handset volume (even during a call), see page 18.

Making an internal call

You can conduct **internal calls with up to 6 handsets**.



Press the INT key – the handset's internal call number is displayed.

e.g.   2

Enter the internal call number of the handset you want to call.

Press  to call all handsets.



Ending a call:

Press the end call key.

Making calls

Press keys:

Answering a call

A call is signalled by the ringer.

Either press the talk key

or



if the auto talk feature is activated, remove the handset from its base station.



For information on setting the handset's handset volume (even during a call), see page 18.

Displaying the incoming call number (CLIP)

If calling line identification presentation (CLIP) is supported by the network carrier, the caller's number and **EXT** appear on the handset's display:

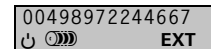
e.g. 

or

--- and **EXT** if the number was not received or
-----, if the number has been suppressed by the caller

or

the internal call number of another handset and **INT**.

Muting the microphone

You can deactivate your microphone during external calls in order, for example, to talk privately to somebody in the room. The calling party cannot hear your conversation during this time.



Mute the microphone – the calling party on hold will hear music .



Re-activate the microphone.

Paging



Press the **base station key** – all handsets ring.



Ending paging:

Press the base station key again or press the talk key  on a handset.

Enhanced telephone features

Press keys:

Enhanced telephone features

Redial

Your handset automatically stores the last five call numbers dialed. You can dial, change, display and delete these numbers.

Redialling a number



Display call numbers – the last number dialed is displayed:

e.g. Call number
Memory location



Select a call number.



Press the talk key to start dialling.

- **Display keys** , see also page 3!
- **Modifying the call number displayed:** and supplement or press to correct.

Deleting all numbers

All **five redial numbers** are deleted.

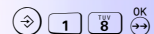

Initiate the function.

Enter the handset's telephone PIN and confirm (factory setting: 0000).

Telephone PIN



Delete all numbers.



Confirm the delete action and terminate the function.

Speed dialling

The speed dialling list simplifies dialling for up to 10 call numbers.

- Numbers can also be saved **during** a call!
- **Display keys** , see also page 3!

Enhanced telephone features

Press keys:

Saving/changing/deleting call numbers



Press the set key and then the speed dialling key – the entry for speed dialling number 1 is displayed:

e.g. Blank or call number
Speed dialling number (mem.loc.)

e.g. or

Enter the speed dial number (digit **0 to 9**) or press to scroll to the speed dialling number you want to dial.

Confirm the selection.



Enter a new call number (destination) or change an existing call number. If necessary, delete the entire call number with .

Save the number – you will hear the confirmation beep. To save additional numbers: press again, enter the speed dialling number and proceed as described above.



Terminate the function.

Speed dialling



Press the speed dial key.

e.g.

Enter the speed dial number (digit **0 to 9**) or scroll with .



Dial the call number.

- **Changing a speed dial number before dialling:** Confirm the number displayed with , change the number and dial with .

Saving a call number from the redial list



Press the set key followed by the speed dial key.

e.g. or

Enter the speed dial number (digit **0 to 9**) and confirm.

Select a call number in the redial list.



Save the call number (confirmation beep) and terminate the function.

Deleting the speed dial list

All numbers are deleted!

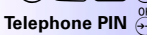
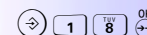

Initiate the function.

Telephone PIN

Enter the handset's telephone PIN and confirm (factory setting: 0000).



Confirm the delete action and terminate the function.

Enhanced telephone features

Press keys:

Caller list/mailbox function

If transferred, the call numbers for the **last 30 incoming calls** are stored in the caller list. **New entries** in the caller list are indicated by the ☐ icon.

Dialling a number



Initiate the function – the following displays flash alternately:

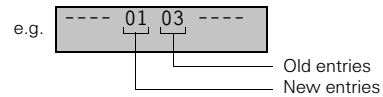

and the **call number of the 1st entry:**

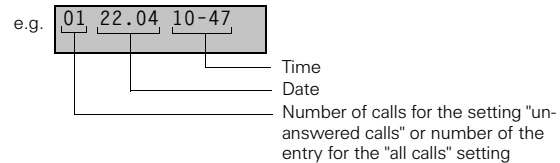

Scroll down to the required entry.

Dial the call number – the entry is deleted from the caller list and stored in the redial list.

Caller list settings

You can make the following settings:

- only **unanswered calls** are saved (factory setting) **or**
- **all incoming calls** are saved



This operation **deletes all entries!**



e.g.

Initiate the function.

For example, **all calls** are to be saved.
Unanswered calls = **1**, all calls = **2**



Saving settings and terminate the function.

Deleting the caller list

All entries are deleted!



System PIN

Initiate the function.

Enter the base station's system PIN and confirm (factory setting: 0000).

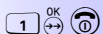

Delete the caller list and terminate the function.

Cost-effective telephoning

Press keys:

Cost-effective telephoning

Network access support

This function simplifies the dialling operation when using a telephone company **other than** your local telecom company.

● Using the speed dial key

- Save the call number of the telephone company as the speed dial number "0", see "Speed dialling" page 14.
- **Hold down the speed dial key**  to display the telephone company's call number saved as speed dial number "0".

Prerequisite: number is saved.



Hold down the speed dial key – the telephone company's prefix code is displayed.



Enter the user's call number.



Press the talk key and dial the **complete number**.

● By "linking" the speed dial list

You can **save** prefix codes for various telephone companies **as numbers** and use them as follows when dialling:

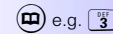

e.g.  3

Display the prefix code you want to dial.



Confirm the prefix code.



e.g.  50

Enter the user's call number from the speed dial list **or** enter it manually.



Press the talk key and dial the **complete number**.

Displaying the call duration



The handset automatically displays the current call duration.







Individual handset settings

Press keys:

Individual handset settings







Setting the ringer volume 

You can choose between **5 ringer volumes** (ringing) and the "crescendo" ring (increasing volume).

-   **5** 
- Initiate the function – you will hear the current ringer.
- e.g.  **4** 
- Enter the number of the required ringer volume.
Volume levels = **1 to 5**; crescendo = **6**
-  
- Save the setting.







Setting the ring melody 

You can choose between **10 ring tones**.

-   **6** 
- Initiate the function – you will hear the current ring.
- e.g.  **3** 
- Enter the desired ring tone (**0 to 9**).
-  
- Save the setting.

Setting the handset volume

You can set the **handset volume** (volume of the conversation) to any of **3 levels** – even during a call.

-  **1** **0** 
- Initiate the function.
- e.g.  **2** 
- Enter the handset volume required (**1, 2 or 3**).
-  
- Save the setting.
- 
- Terminate the function (**do not press** this key during a call).

Activating/deactivating beeps







You can activate/deactivate the following warning and signal tones:

- **Confirmation beeps:** confirmation beep (1 tone) when you conclude inputs/settings; error beep (4 short tones) when you make an incorrect entry.
- **Key beep:** every keystroke is confirmed.
- **Battery warning beep:** the battery must be charged.







Individual handset settings

Press keys:

Activating/deactivating confirmation beeps







-  **1**  **3** 
- Initiate the setting.
- e.g.  **0** 
- For example, deactivate confirmation beeps.
Deactivate = **0**; activate = **1**
-  
- Save the setting and terminate the function.

Activating/deactivating key beep

-  **1**  **4** 
- Initiate the setting – the current setting is displayed.
- e.g.  **0** 
- For example, deactivate the key beep.
Deactivate = **0**; activate = **1**
-  
- Save the setting and terminate the function.







Activating/deactivating the battery warning beep

The battery warning beep is generated when the charging status of the battery in the handset falls below a predefined level.

-  **1**  **5** 
- Initiate the setting.
- e.g.  **0** 
- For example, deactivate the battery warning beep.
Deactivate = **0**; activate = **1**;
battery warning beep only during a call = **2**
-  
- Save the setting and terminate the function.







Activating/deactivating base station display

If the display is activated, the currently valid base station is displayed when the handset is idle, e.g. –1–.

-  **1**  **6** 
- Initiate the setting.
- e.g.  **1** 
- For example, activate the display.
Activate = **1**; deactivate = **0**
-  
- Save the setting and terminate the function.

Auto talk

When this function is active, you can answer a call by removing the handset from the base station/charging unit.

-  **1**  **7** 
- Initiate the setting.
- e.g.  **0** 
- For example, deactivate auto talk.
Deactivate = **0**; activate = **1**
-  
- Save the setting and terminate the function.

Individual handset settings

Press keys:



Telephone PIN

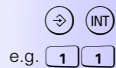

e.g. 1 1



Resetting the handset to factory default

This setting does **not** delete the **telephone PIN**.
Base station registrations are maintained.

Handset factory settings:

Speed dial numbers, redial, hot key number	deleted
Handset volume, ring tone	1
Ringer volume	6
Auto talk, key beep, battery warning beep, confirmation beep	on
Base station display	off

Initiate the setting.

Enter the telephone PIN and confirm
(factory setting: 0000).

Reset settings to factory default and terminate the function.

Registering at more than one base station

You can operate your handset at up to **4 base stations**.

For information on registration at **Gigaset 3010**, see page 30!

Changing the base station

Prerequisite: the handset is registered at several base stations.

You can choose one of the following:

- Set the handset to **automatically select** the best base (factory setting).
- Set the handset to **priority base station** – the handset searches for other base stations if this is not found within 30 seconds.
- Set the handset to **a fixed base station**.

Press the set key followed by the INT key.

For example, set Base 1 as the priority base.

For **automatic selection**: enter **0**.

For **priority base**: enter the base number **twice**.

For **fixed base**: enter the base number **once**.

Save the setting and terminate the function.

Base station settings

Press keys:

Base station settings

All base station settings are made **via the handset**.

Setting the date/time

Setting the date

The date setting is required to display the date on which the message was received by the caller list.

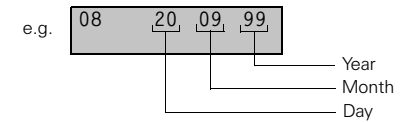

Initiate the setting – the current setting is displayed; the current input position flashes:



 **0** 

e.g.  **2** **0**

e.g. **0** 

e.g.  **9** 

Enter the **day**.

If necessary, press  to jump back and start again.

Enter the **month**.

Enter the **year**.

Save the setting and terminate the function.

Setting the time

The time setting is required to display the time at which the message was received by the caller list.

Initiate the setting – the current setting is displayed; the current input setting flashes:

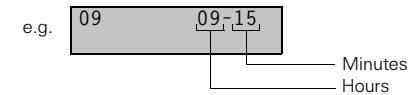

 **0** 

e.g. **0** 

1 or 

e.g. **1** 

Enter the **hours**.

If necessary, press  to jump back and start again.

Press **1** for AM or  for PM.

Enter the **minutes**.

Save the setting and terminate the function.

 The date and time must be reset after a power cut or disconnecting the base station's AC adapter and plug.

Base station settings

Press keys:



e.g.



Setting the ringer volume

You can choose between **5 ringer volumes**, the "**crescendo**" ring (increasing volume) and **ringer off**.

Initiate the setting – the ringer sounds, the current setting is displayed.

Enter the number corresponding to the required ringer volume.

Volume levels = **1 to 5**

crescendo = **6**

ringer off = **0**

Save the setting.

Setting the ring melody

You can choose between **10 ring tones**.



e.g.



Enter the desired ring tone (**0 to 9**).

Save the setting.

Activating/deactivating music on hold

This refers to the music that the caller hears when placed on hold, e.g. during an internal enquiry call.



System PIN

e.g.



Initiate the setting.

Enter the base station's system PIN and confirm (factory setting 0000).

For music on hold.

Deactivate = **0**; activate = **1**

Save the setting.

Base station settings

Press keys:



System PIN

e.g.



System PIN

e.g.



Setting pauses

Pause after picking up an outside line

You can use this function to set the length of the pause that is automatically inserted after you press the talk key and before the call number is transmitted.

Initiate the function.

Enter the base station's system PIN and confirm (factory setting: 0000).

e.g.

Enter the pause length.

1 second = **1**; 3 seconds = **2**; 7 seconds = **3**;

2,5 seconds = **4**.

Confirm the setting and terminate the function.

Pause after the recall key

You can use this function to set the length of the pause that is inserted with the recall key when dialling, e.g. specific international numbers.

Initiate the function.

Enter the base station's system PIN and confirm (factory setting: 0000).

e.g.

Enter the pause length.

0,8 seconds = **1**; 1,6 seconds = **2**; 3,2 seconds = **3**

Save the setting and terminate the function.

Base station settings

Press keys:

Resetting the factory settings

When resetting the base station, the **system PIN is not changed** and handset registration is not affected. You can:

- reset **all** factory settings, see table below
- delete the **caller list** only

Base station factory settings:

Ringer volume	5
Ring tone	1
Disable/enable call numbers, base lock, automatic prefix	Off
Number for disabling/enabling, stored emergency numbers	Deleted
External dialling (all handsets)	Possible
Dialling mode	DTMF, adjustable flash
Flash time (at telephone systems)	300 ms
Pause after recall key	800 ms
Pause after picking up line/ dial-out code	2 s



System PIN

0



Initiate the setting.

Enter the base station's system PIN and confirm (factory setting: 0000).

For example, reset setting to the factory default. Reset to factory default = **0**; delete caller list = **1**;

Confirm the delete action and terminate the function.

Press keys:



Handset security

You can change the telephone PIN, configure direct station selection or lock your telephone (handset).

Changing the telephone PIN

Important functions/settings are protected by the handset's telephone PIN (**P**ersonal **I**dentification **N**umber).

Do not forget your PIN! The PIN can only be reset by calling the **Siemens hotline**, see page 40.

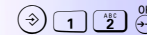

Initiate the function – the following appears:

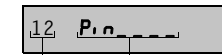

Information on PIN input
Function code entered previously

Telephone PIN
2x new PIN

Enter the current telephone PIN and confirm (factory setting: 0000).

Enter the new telephone PIN twice (4 digits, a dash is deleted every time a digit is entered).

Confirm the new telephone PIN – you will hear the confirmation beep, the new PIN is saved.

Terminate the function.

Activating the telephone lock



All functions with the exception of emergency call are unavailable when the telephone (handset) is locked. You can still be reached, however. Simply press the talk key  to accept a call.

Initiate the function.

Enter the telephone PIN and confirm (factory setting: 0000).

Activate the telephone lock.

Save the setting – you hear the confirmation beep,  appears on the display.

Ist keine Direktrufnummer gespeichert (Anzeige ), so wird nach Drücken von  die Telefonsperre eingeschaltet – Anzeige .

Direktrufnummer/Telefonsperre ausschalten, siehe unten.



Telephone PIN



Handset security

Press keys:



Press the talk key.

Enter the emergency number.



Telephone PIN

Initiate the function.

Enter the telephone PIN and confirm
(factory setting: 0000).



Deactivate the telephone lock.

Save the setting and terminate the function.

Dialling an emergency number

Prerequisite: you have saved the emergency number in the base station, see page 29, and the handset is locked.

Deactivating the telephone lock

Base station security

Press keys:



Base station security

Changing the base station's system PIN



System PIN

2x new PIN



Initiate the function.

Enter the current system PIN and confirm (factory setting: 0000).

Enter the new system PIN (4 digits) twice.

Confirm the new base station PIN – when you hear the confirmation beep, the new PIN has been saved.

Terminate the function.

Activating/deactivating the base lock

Outgoing external calls are blocked **for all handsets** when the base is locked.

Stored **emergency numbers** can be dialled.



System PIN

e.g. **2**



Initiate the function.

Enter the system PIN and confirm (factory setting: 0000).

To activate the base lock.
Activate = **2**; deactivate = **0**

Save the setting and terminate the function.

Base station security

Press keys:

Barring/enabling call numbers

You can use this function to **bar specific call numbers**, e.g. all international numbers (00...). You can also specifically **enable these numbers**. Barring/enabling actions affect **all handsets**.

All external numbers dialled are checked. Dialling is cancelled and the barred digits are displayed if the call number matches the **barred number**. This does not happen if the **number is enabled**.

Saving/changing/deleting call numbers

You can save 5 numbers. The numbers can be displayed, changed, and deleted at any time.

Initiate the function.

Enter the system PIN and confirm (factory setting: 0000) – the first entry is displayed:

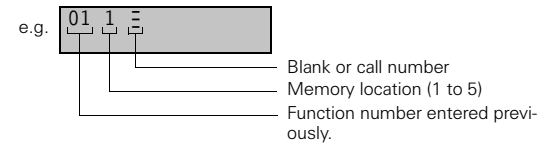

If necessary, press  to scroll to the required entry (memory location).

Select the entry displayed.

Enter the call number, e.g. **00** to bar **international calls**, or change. If necessary, press  to delete the number

Save the entry and terminate the function **and now activate barring/enabling** as described below.

Activating/deactivating call barring/enabling

Initiate the function.

Enter the system PIN and confirm (factory setting: 0000).

e.g. bar numbers.
Bar numbers = **1**;
Enable numbers = **3**;
Deactivate call barring/enabling = **0**

Save the setting and terminate the function.

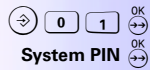

System PIN

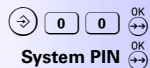

System PIN



Base station security

Press keys:

Saving emergency numbers

You can save **5 emergency numbers**. The emergency numbers are valid for **all handsets**.

 An **emergency number can be dialled**, even if the telephone is locked.

Saving/changing/deleting emergency numbers

Initiate the function.

Enter the system PIN and confirm (factory setting: 0000) – the 1st entry is displayed:

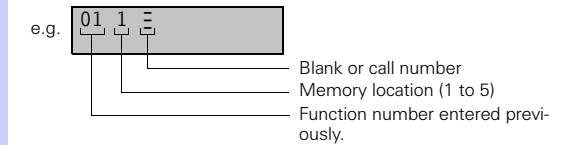

If necessary, press  to scroll to the required entry (memory location).

Select the entry displayed.

Enter or change the emergency number (up to 16 digits). If necessary, press  to delete the number.

Save the entry and terminate the function.

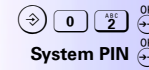

System PIN



Operating more than one handset

Press keys:

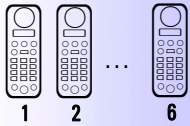

Operating more than one handset

Registering additional handsets

- You can register and operate up to **6 handsets** at your 3010 base station.
- A Gigaset 3000 Classic handset can be registered at up to 4 base stations.

Registering a Gigaset 3000 Classic handset

The **handset** is already registered at the base station when **shipped**.

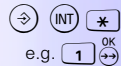

e.g. **1**

Initiate registration – the base station numbers are displayed.

Enter the **number of the base station** and confirm with .
Base station 1=**1**; base station 2=**2**;
Base station 3=**3**; base station 4=**4**

Normally, enter **1** for base station 1 when registering for the first time. When registering the handset at additional base stations, e.g. at work, enter **2**, **3** or **4** as the number of the base station.

System PIN

Enter the base station's system PIN and confirm (factory status: 0000) – the base icon is flashing.

At base station

Press the base station key until a signal tone is generated at the base station (hold key down for approx. 10 seconds) – unassigned internal call numbers are displayed after a few seconds, e.g. 23456 (number 1 is assigned to the handset supplied).

e.g. **2**

Enter the **internal call number of the other handset** – the **stationary** base icon is displayed **if registration is successful** (stops flashing).

Your handset is ready for operation!

Operating more than one handset

Press keys:



• Registering Gigaset 1000/2000

For information on preparing these handsets, see the relevant operating instructions.

• Registering third-party handsets

Prerequisite: the non-Siemens handset complies with the **GAP** standard!

GAP (Generic Access Profile) is a European standard for the interaction of cordless telephones and base stations.

Refer to the operating instructions of the handset to be registered for information on how to register it at a **GAP base station**.

Preparing your base station for registration:

Press the base station key **until a signal tone** is given by the base station (hold down for approx. 10 seconds).

Your Siemens base station assigns the **first unassigned** internal call number to the handset on registration.

At base station

Making an internal call

Internal calls are conducted with your other registered handsets – free of charge



Press the INT key – the relevant internal call number is displayed.

e.g. **2**

Enter the internal call number of the handset you want to call. Press to call all handsets .

Ending a call:



Press the end call key.

Forwarding a call

You can forward an external call to another handset. (connect).



Press the INT key – the external user hears music on hold.

e.g. **2**

Dial the internal call number of the handset.



When the user answers:

Press the end call key to transfer the call.

Operating more than one handset

Press keys:

Internal enquiry call

You are on a call with an external user. You can call another internal user for an enquiry call without clearing down the initiated connection. You are automatically reconnected to the external user when you end the enquiry call.



The external user (call) is placed on hold and can hear music on hold.

e.g. 2

Dial the internal number of the handset you want to call. Press to call all handsets.



End the enquiry call to revert to the caller placed on hold.

Accepting call waiting

The call waiting tone (1 brief tone) is generated when you receive an external call while conducting an internal call; **EXT** flashes on the display.



Press the end call key – the **internal call is cleared down**. Wait for the external call (auto talk).



Answer the external call when the handset rings.

or



Press the recall key – the **internal call is cleared down** and you are immediately connected to the external caller.

Collective call

All handsets are called and ring. You can accept the call at any handset by pressing the talk key .



Press the INT key.



Press the display key – all available handsets are displayed. The busy tone is generated if there is no available handset.

Displaying the handset number



Press the INT key – the handset's internal call number is displayed.



Ending the display:
Press the end call key.

Operating more than one handset

Press keys:

Open listening at the handset

Prerequisite: at least 2 handsets are registered.

You can use this function to listen in on an external call at another handset.

You are conducting a call with an external user:

The call is placed on hold.



e.g. 2

Enter the call number of the other handset – the other handset rings, the other internal user presses the talk key .



You are reconnected to the external user. The other internal user can hear the conversation.

Deactivating open listening:



The external connection is not affected, the internal user hears the busy tone.



The internal user can terminate open listening by replacing the handset.

De-registering handsets

A handset that has been de-registered from a base station (e.g. to protect against unauthorised use) cannot be used to make calls at this base station.



System PIN

Initiate de-registration.

Enter the system PIN and confirm (factory setting: 0000) – the numbers of all registered handsets are displayed.

e.g. 2

Enter the internal call number of the handset **to be de-registered** (number is no longer displayed).



Confirm de-registration.

Operating more than one handset

Press keys:

Disabling external dialling from individual handsets

The factory setting permits you to make external calls from each registered handset. You can use the disabling function to **prevent external numbers** being dialled from **individual handsets**.

You can use "blocked" handsets to:

- make internal calls
- accept external calls
- dial the emergency numbers saved at the base station (see page 26).



System PIN

Initiate the setting.

Enter the system PIN and confirm (factory setting: 0000) – the numbers of all registered handsets are displayed.

e.g. **2**

Enter the internal call number of the **handset to be disabled**.

e.g. **0**

For example, deactivate external dialling (block).
Deactivate = **0**; activate = **2**



Save the setting and terminate the function.

Connecting a fax/modem

You can register fax machines, modems and "stationary" telephones at the base station in the same way as a handset via a cordless **Gigaset 1000 TAE** connector. To do this, you must modify the **device type for the Gigaset 1000 TAE** as described below:



System PIN

Initiate the function.

Enter the system PIN and confirm (factory setting: 0000) – all registered handsets are displayed.

e.g. **4**

Enter the internal call number of the TAE.

e.g. **1**

Set the device type.
"stationary " telephone/handset = **1** (factory setting); fax = **2**; modem = **3**



Save the setting and terminate the function.

Operating more than one handset

Press keys:

Activating/deactivating the ringer

All handsets ring immediately to signal an incoming external call – collective call (factory setting). The calls can be accepted at all handsets by pressing the talk key

However, you can **deactivate** the ringer on **individual handsets** – these handsets will no longer ring when external calls are received.



System PIN

Initiate the setting.

Enter the system PIN and confirm (factory setting: 0000) – all handsets **with ringer on** are displayed.

e.g. **3**

Enter the internal call numbers of the handset:

- call number is **displayed** = ringer **on**,
- call number is **not displayed** = ringer **off**.



Save the setting and terminate the function.

Setting ring delay/collective call

You can use this function to switch from collective call (factory setting) to ring delay. When ring delay is switched on, external calls are signalled first at the priority handset:

- If **collective call** is activated, **all handsets ring immediately** when external calls are received
- If **ring delay** is activated, calls are signalled first at the **priority handset** and then at the other handsets after a pre-determined number of rings. The priority handset and the ring delay (number of rings) must first be defined.



System PIN

Initiate the setting.

Enter the system PIN and confirm (factory setting: 0000).

e.g. **2**

e.g. set the ring delay.
Collective call = **1**; ring delay = **2**



Save the setting and terminate the function.

Operating more than one handset

Press keys:

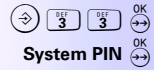

System PIN



e.g.

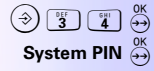

System PIN



e.g.

Setting a priority handset

The handset with 1 as call number is automatically the priority handset – and rings first (factory setting).

You can set any **other handset** as the **priority handset**:

Initiate the function.

Enter the system PIN and confirm (factory setting: 0000) – the priority number is displayed.

Enter the call number of the **priority handset**.

Save the setting and terminate the function.

Setting ring delay

You can set the **number of rings** allowed before the call is signalled at the **other handsets**.

Initiate the function.

Enter the system PIN and confirm (factory setting: 0000) – the current setting is displayed, e.g. 3.

Enter the number of rings.

The call is signalled at the telephone after: 2 rings = **2** to 9 rings = **9**

Save the setting and terminate the function.

Connecting to a PABX

Press keys:

Connecting to a PABX

Setting the dialling mode

Only necessary if your PABX does **not** operate with **DTMF** (dual-tone multifrequency signalling), and flash – see the operating instructions for your PABX.

Options:

- DTMF, adjustable flash time
- DP (dial pulsing)

Setting the dialling mode:

System PIN OK

e.g. 2 OK



Initiate the function.

Enter the system PIN and confirm (factory setting: 0000).

Set the dialling mode.

DTMF, flash = **1**; DTMF, adjustable flash time = **2**; DP = **4**

Save the setting and terminate the function.

Setting the flash time

Prerequisite: you switched to DTMF, adjustable flash time as described but your PABX requires a different flash time.



System PIN OK

e.g. 1 OK



Initiate the function.

Enter the system PIN and confirm (factory setting: 0000).

Set the flash time.

80 ms = **1**, 100 ms = **2**, 120 ms = **3**, 180 ms = **4**,
250 ms = **5**, 300 ms = **6**, 600 ms = **7**

Save the setting and terminate the function.

Switching to tone dialling

If you are operating the base station at a PABX with dial pulsing (DP), you can switch to tone dialling (DTMF), for example to check an answering machine.

Prerequisite: a connection is active.



Press the set key.



Activate tone dialling – tone dialling is active until the call is cleared down.

Connecting to a PABX

Press keys:

Saving a dial-out code

Prerequisite: a dial-out code must be dialled before the actual call number on all external calls.
The dial-out code is also known as a **prefix code or system code (SC)**.



- Please note that the dial-out code must be entered when saving **emergency numbers, call numbers for the speed dialling list** and **network provider prefix numbers**.
- Since an **emergency call cannot** be made with the saved emergency numbers, you should **re-save** the emergency numbers with the dial-out code for security reasons.
- The **dial-out code** that you save "here", is always automatically inserted before the call numbers in the caller list and dialled.



System PIN

e.g. **0**



Initiate the function.

Enter the system PIN and confirm (factory setting: 0000).

Enter the dial-out code (up to 3 digits) or change.

Save the setting and terminate the function.

Pause after dial-out code

Prerequisite: you have saved a dial-out code and would like to change the default pause.

The pause set here is always inserted by the base station after the dial-out code. For information on whether and how long this pause must be, see the operating instructions for your PABX.



System PIN

e.g. **1**



Initiate the setting.

Enter the system PIN and confirm (factory setting: 0000).

Enter the pause length.

1 second = **1**; 2 seconds = **2**; 3 seconds = **3**; 6 seconds = **4**



Save the setting and terminate the function.





Appendix

Maintenance

- Simply wipe the base station and handset with a damp cloth or an antistatic wipe. **Never** use a dry cloth as this can cause static discharge.

Troubleshooting

-  Resetting the handset factory settings, see page 20.
-  Resetting the base station factory settings, see page 23.

Fault	Possible cause	Solution
No display	Handset not activated Batteries flat	Hold down the end call key  for 1 second Charge the batteries.
No reaction to key-stroke	Keypad protection activated	Hold down the  key for 1 second
No radio connection to the base station – U flashing!	Handset outside the base station range Handset not registered Base station not activated	Move closer to the base station Register the handset (page 30) Check the connector at the base station (page 8)
Handset does not ring	Ringer off	Activate the ringer (page 35)
External call numbers cannot be dialled	Base lock activated Handset lock activated Call number matches a barring code External dialling disabled	Deactivate lock (page 27) Deactivate lock (page 26) Barring codes (page 28) Disable external dialling (page 34)
The called party cannot hear	The  was pressed – the microphone is switched off.	Press  to activate the microphone
The caller's number is not displayed	Call number not transmitted	Request call number transmission feature from telephone company

Appendix

Guarantee/service/approval

Guarantee

Siemens AG offers a twelve-month warranty for this device from the date of purchase from the dealer. Always retain receipts as proof of date of purchase.

Over this warranty period, Siemens AG will rectify all material or manufacturing defects by repairing or exchanging the defective terminal. Siemens AG reserves the right to fulfil the warranty conditions by repairing or replacing the defective terminal.

The warranty does not cover damage caused by incorrect use, wear and tear or third party access. The warranty does not cover consumables or defects which only have a minor effect on the value or operability of the terminal.

The Siemens product purchased complies with the technical requirements for connecting to the Hong Kong public telephone network.

For warranty claims, please contact Siemens Service Centre.

Service

Service contact:

Great Britain: 0345 908070



Siemens Service should only be contacted if problems arise with the unit. Your specialist dealer will be happy to answer any questions on unit operation. Contact your network provider for questions concerning telephone connections.

Approval

Gigaset 3010 Classic has been approved for operation in your country, as shown on the underside of the base station.

Approval in compliance with I-CTR 37 (from gazette):

"This equipment has been approved to [Council Decision 99/303/EC - "CTR 21"] for pan-European single terminal connection to the Public Switched telephone Network (PSTN). However, due to differences between the individual PSTNs provided in different countries, the approval does not, of itself, give an unconditional assurance of successful operation on every PSTN terminal point.

In the event of problems, you should in the first instance contact your equipment supplier."

Index

Index

A

Activating

- battery warning beep 19
- beeps 18
- confirmation beep 19
- handset 11
- key beep 19
- keypad protection 11
- music on hold 22
- telephone lock/direct station selection 26

Approval 40

Auto talk 19

Auto talk (automatic) 19

B

Base lock, activating/deactivating 27

Base station

- activating/deactivating music on hold 22
- changing 20
- connecting 8
- installing 7
- resetting the factory setting 23
- setting pauses 23
- setting the date 21
- setting the ring melody 22
- setting the ringer volume 22
- setting the time 21

Batteries, inserting and charging 9

Battery warning beep 18

Beeps

- battery warning beep 18
- confirmation beeps 18
- key beep 18

Belt clip 11

Brief overview

- handset 3

C

Call duration, displaying 17

Call numbers, barring/enabling 28

Call waiting

- accepting a call 32

Call, connecting 31

Caller list 16

Calls

- external 12
- internal 31

CLIP (call number display) 13

Collective call 32

Collective call/ring delay, setting 35

Confirmation beeps 18

Connecting 31

Contents of the package 7

D

Deactivating

- battery warning beep 19
- beeps 18
- confirmation beep 19
- handset 11
- key beep 19
- keypad protection 11
- music on hold 22
- telephone lock/direct station selection 26

Display (symbols/keys) 2, 3

DP (dial pulsing) 37

DTMF (dual-tone multifrequency signalling) 37

E

Emergency number

dialling 26

saving 29

Enquiry call (internal) 32

Error beep 18

F

Fault clearance 39

Fax/modem, connecting 34

Flash time 37

Forwarding 31

G

GAP standard 31

Guarantee 40

H

Handset

- activating/deactivating 11
- activating/deactivating base station display 19
- changing to another base station 20
- de-registering 33
- disabling external dialling 34
- displaying an internal number 32

Index

- preparing 9
 - registering additional handsets 30
 - registering at more than one base station 20
 - resetting the factory settings 20
 - Handset lock
 - activating 25
 - deactivating 26
 - Handset settings (overview) 4
 - Handset volume, setting 18
- K**
- Key beep, activating/deactivating 19
 - Keypad protection 11
- M**
- Mailbox function 16
 - Making calls
 - answering calls 13
 - external 12
 - internal 31
 - Making external calls 12
 - Malfunctions (troubleshooting) 39
 - Microphone, muting 13
 - Modem/fax, connecting 34
- N**
- Network access 17
- O**
- Open listening 33
- P**
- PABXs
 - flash time 37
 - saving a dial-out code 37
 - saving a pause after a dial-out code 38
 - setting the dialling mode 37
 - switching to tone dialling 37
 - Paging (searching for handsets) 13
- PIN, changing
 - base station PIN 27
 - handset PIN 25
- Q**
- Quick reference guide 4
- R**
- Range 7
 - Redial 14
 - Ring tone, setting 18
 - Ringer 35
 - Ringer volume, setting 18
 - Ringer, activating/deactivating 35
- S**
- Safety precautions 2
 - Saving
 - emergency number 26
 - speed dial number 15
 - system PIN 27
 - telephone PIN 25
 - Service 40
 - Settings
 - base station ring melody 22
 - base station ringer volume 22
 - date 21
 - handset ring tone 18
 - handset ringer volume 18
 - handset volume 18
 - pauses 23
 - time 21
 - Settings - overview, Cover
 - Speed dialling 14
- T**
- Telephone lock 25
 - Telephone maintenance 39
 - Tone ringer 35
 - Troubleshooting 39

Settings – overview

Handset settings

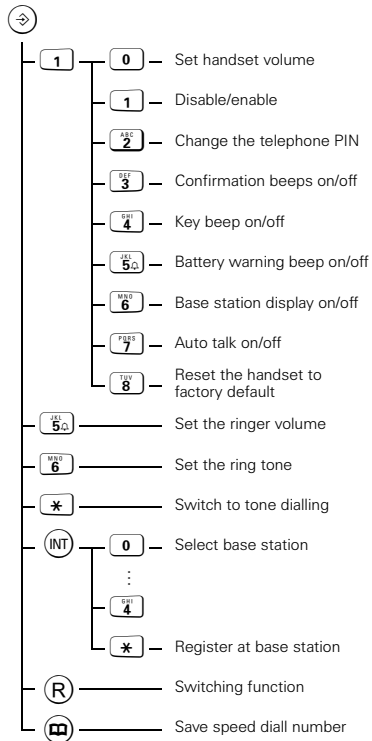

Base station settings

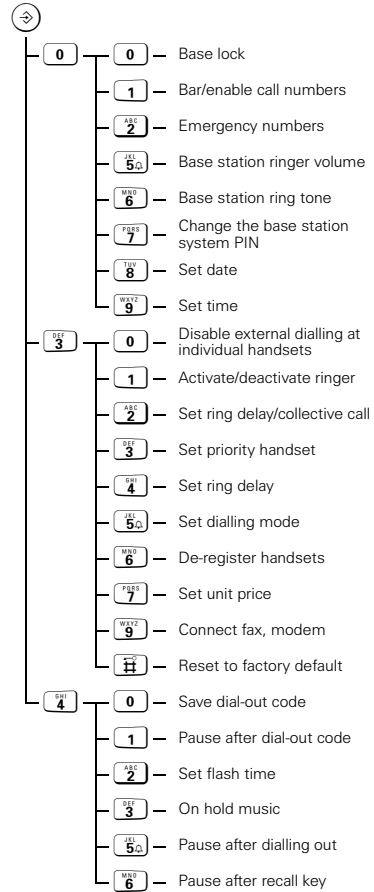

Issued by
Information and Communication Products Group
Hofmannstraße 51, D-81359 München

Siemens Aktiengesellschaft

im Internet: <http://www.siemens.com/gigaset>

© Siemens AG 1999. All rights reserved.
Subject to availability.
Right of modification reserved.

Reference no.: A31008-G3010-H001-1-7619
Printed in Germany
09/99