

The cordless USB interface  
for connecting PCs to Gigaset 3070/75isdn



## Operating Instructions

### Note

Please read the safety precautions outlined in these operating instructions before putting the unit into service!

[How to use this manual](#) 

[Contents](#) 

[Index](#) 

# How to use this manual

The following controls are available in Acrobat Reader or in the context menu (right mouse button):



Click here when you see this hand.

## Contents

<b>Introduction</b> .....	<b>9</b>
What is a Gigaset M101 Data? .....	9
Meaning of "local adapter" and "remote adapter" .....	10
Meaning of "base" and "portable part" .....	10



Click here to jump to this section.

**11.** It may be useful to switch the operating mode from "AT commands (PC)" to one of the two other operating modes. This setting concerns the protocol on the serial interface, especially the speed adjustment. **"Setting the operating mode" on page 15.**

**12.** Close the program with "OK".

In the event of errors or for further information, see **"Configuration program options" on page 12.**

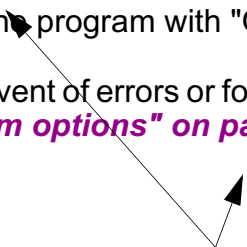

Click here to jump to this section.



Click here to jump to the table of contents.



Click here to jump to the index.

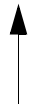

Jump back to the last position shown.

## Overview



### Front

- 1. Operating LED, illuminated when power supply is active, see "LEDs" on page 25
- 2. Data LED, illuminated during data transfer operations

**Side**  
Port for the USB cable



# Contents

How to use this manual .....	2
Overview .....	1
<b>Introduction .....</b>	<b>4</b>
What is a Gigaset M105 Data? .....	4
Meaning of "local adapter" and "remote adapter" .....	4
Meaning of "base" and "portable part" .....	5
Contents of the package .....	5
Installation .....	5
<b>Configuration .....</b>	<b>8</b>
Registering Gigaset M105 Data at Gigaset 3070isdn/3075isdn .....	8
Registering Gigaset M105 Data at Gigaset M105 Data .....	10
Registering Gigaset M105 Data at Gigaset M101 Data .....	11
<b>Configuration program options .....</b>	<b>12</b>
General .....	12
Starting the configuration program .....	12
"Connection" tab .....	13
Upper section: connecting to the PC .....	13
Lower section: DECT connection .....	14
"Operating mode" tab .....	15
Setting the operating mode .....	15
Special features with Direct Connection .....	16
Special settings for "Direct connection" mode .....	17
"Local adapter" tab .....	20
Changing the name .....	20
Change adapter type .....	20
Change PIN ... ..	20
Registering a portable part .....	21
De-registering a portable part .....	22
Automatic enabling .....	22
Manual enabling .....	22
"Remote adapter" tab .....	23
Changing the name .....	24
Change PIN .....	24
LEDs .....	25
LED 1: Gigaset M105 Data status .....	25
LED 2: data transfer .....	25
Notes on installation and operation .....	26
Place of installation .....	26
Temperature and ambient conditions .....	26
Why set an operating mode? Technical background .....	27



Special features when connecting two Gigaset M105 or M101 Data units .....	27
Notes on the COM interface .....	27
<b>Tips&amp;tricks, settings .....</b>	<b>29</b>
Access to different V.24 terminals from a laptop: .....	29
Sequential access from multiple computers to a terminal: .....	30
<b>What happens if... .....</b>	<b>31</b>
Support .....	32
Updates and news on the Internet .....	32
Notes on sending faxes directly from the PC .....	32
Problems with application programs .....	33
Technical data .....	35
Safety precautions .....	36
<b>Index .....</b>	<b>37</b>



# Introduction

## What is a Gigaset M105 Data?

Your Gigaset M105 Data is a cordless USB interface for operation at the Gigaset 3070/75isdn base station, at a second Gigaset M105 Data or at a Gigaset M101 Data (V.24 interface).

	<p>A Gigaset M105 Data unit is powered via the USB port but operates like a COM interface with regard to data.</p> <p><b>The USB cable cannot be extended!</b></p>
---	--

You can thus use this cordless USB port for your PC as an alternative to the integrated USB port at the Gigaset 3070/3075isdn base station.

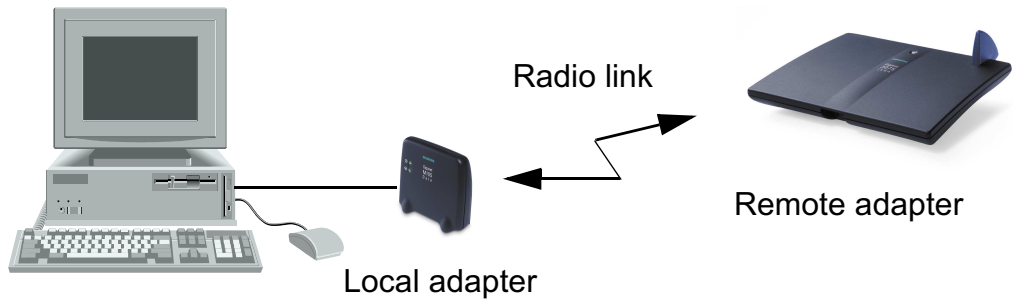

Gigaset M105 Data features of a configuration program.

## Meaning of "local adapter" and "remote adapter"

These names are used for identifying the adapters and their role in data communication. The "Local adapter" is the adapter that performs all configurations (also for the "remote adapter"). This means that the Gigaset M105 Data setup routine does not have to be installed on the second PC in the case of a direct cable connection.



## Meaning of "base" and "portable part"

This is an assignment in the DECT connection (Base FP = Fixed Part, PP=Portable Part) and refers exclusively to the air interface. A base is the same as a base station in Gigaset telephony. Here, portable part is the same as handset. This is defined, for example, through the registration option. Only one Gigaset M105 Data "Portable part" can have an active connection to a Gigaset 3070/75isdn or a Gigaset M101/M105 Data "Base". Up to 6 portable parts or up to 6 bases can be registered (multi-link operation).



The Gigaset Repeater **cannot** be used to extend the radio range for Gigaset M105 Data, although it can for Gigaset handsets.

## Contents of the package

1. Gigaset M105 Data
2. CD-ROM with the installation program and operating instructions
3. Installation brochure
4. USB cable

## Installation

### Prerequisites for installation

For installation, you need:

- an IBM-compatible PC with the following configuration:
  - Windows 98 operating system
  - approx. 5 MB free hard disk memory
  - 1 free USB slot activated in the PC's BIOS
  - CD-ROM drive,
- the CD-ROM containing the installation program



## Installing

1. Switch on the PC.
2. Connect the USB port on the Gigaset M105 Data to the USB interface on your PC by means of the USB cable provided.  
The hardware assistant appears on the screen.
3. Insert the CD-ROM and click **Next**.  
Note: startup is automatic in Win ME.
4. Activate **Search for the best driver for your device** and click **Next**.
5. Activate **CD-ROM Drive**.  
Note: this window does not appear in Win ME.
6. Double-click **Next** and then **Finish**. Repeat this procedure every time the hardware assistant appears (up to three times, you may be prompted to insert the Win 98 CD when activating the first driver). A virtual COM port is now set up.  
Note: Only click **Finish** in Win ME.
7. Select your CD drive in **Explorer** and double click **Setup.exe**.
8. Select an installation language when **Gigaset M 100 Data Setup** opens and click install. Note: if you want to install Acrobat Reader, then do not restart your system now. Instead, install Acrobat Reader from the CD immediately after Gigaset M105 Data and then perform a manual restart.

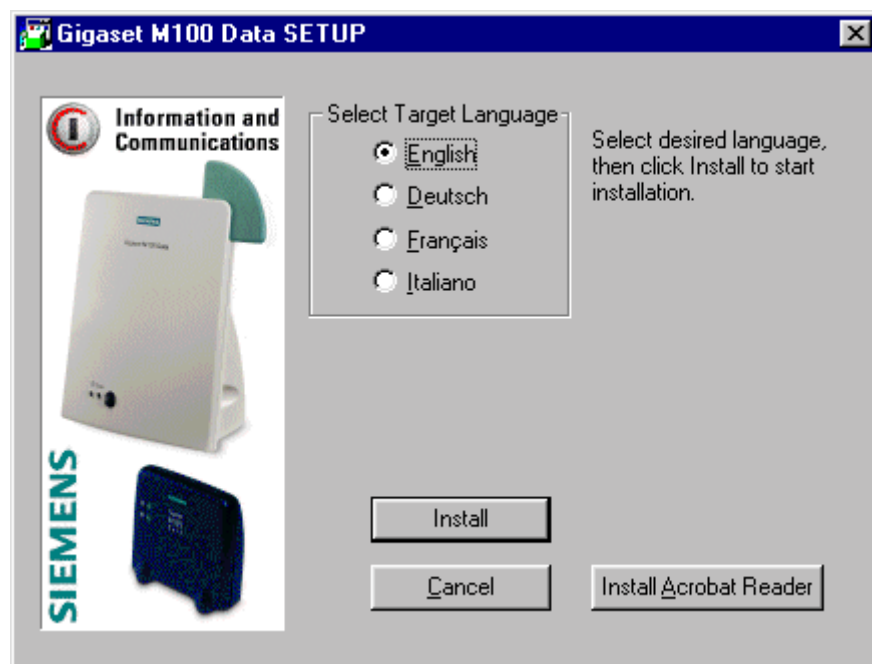



9. The installation program starts. Confirm the **Gigaset M105 Data Properties** Window with **OK**. The configuration program can now be found under **> Start > Programs > Gigaset M100 Data > Gigaset Setup**.

You can now perform initial configuration. Initial configuration is used for registering the Gigaset M105 Data at Gigaset 3070/3075isdn, a second Gigaset M105 Data or a Gigaset M101 Data.



# Configuration

The purpose of configuration is to register the Gigaset M105 Data unit at a Gigaset 3070/3075isdn base station, at a second Gigaset M105 Data or at a Gigaset M101 Data. You can only perform configuration with the configuration program.

## Registering Gigaset M105 Data at Gigaset 3070isdn/3075isdn

### Proceed as follows:

1. Install Gigaset M105 Data.
2. Start the Gigaset M105 Data configuration program via **> Start > Programs > Gigaset M100 Data > Gigaset Setup**.
3. Select the "**Local adapter**" tab, select a free registration location
4. Make sure that your Gigaset M105 Data is set to type **Portable Part** (Auslieferungszustand).
5. Make Gigaset 3070issdn/3075isdn ready for registration by pressing LED.
6. Click the **Register** button and enter the base station PIN (default:0000)
7. Click **OK**. The registration procedure starts and the message "**If the required base is ready for registration, the local adapter logs on. Check that the base is ready for registration.**" appears on the screen. The two devices are automatically synchronised. There is now one entry in the **Registered bases** list.
8. Close the program with **OK**.

**Note:** the telephony drivere event for your Gigaset 3070/3075isdn must be updated after installing Gigaset M105 Data. There are three ways of doing this:

- You haven't operated your Gigaset 3070/3075isdn on your PC using the USB cable before:  
You need to follow the steps described in the sections "PC connection via USB" and "Installing Talk&Surf software" of the installation instructions supplied with the Gigaset 3070/3075isdn. When prompted to specify the port via which the Gigaset 3070/3075isdn is to be accessed, specify the virtual COM port of the Gigaset M105 Data .



- You have operated your Gigaset 3070/3075isdn on your PC using the USB cable before:  
Re-install the Talk&Surf software. Start installing the Talk&Surf software and specify the interface via which the Gigaset 3070/3075isdn is to be accessed, the virtual COM port of Gigaset M105 Data\* when prompted. Proceed with installation.
- You have operated your Gigaset 3070/3075isdn from your PC using the USB cable before and are an experienced PC user:  
Switch the telephony driver by selecting > **Start > Settings > Control Panel > Telephony**. Select the **Telephony Drivers** tab. Select **DECT/ISDN TAPI Service Provider** and click **Configure**. Click **Interface** followed by **Serial** and select the virtual COM port of the GigasetM105 Data. Confirm twice with OK and then click **Close**. Perform a restart.

If Gigaset 3070/3075isdn was already installed, the USB port is automatically assigned. In the case of Internet access via the Gigaset M105 Data, the assigned virtual COM port must be specified for the installation (it is set to serial). This allows you to switch manually from USB to Gigaset M105 Data mode. If the Internet is always to be accessed via Gigaset M105 Data, you can install the Gigaset 3070/3075isdn a second time, the settings for Gigaset M105 Data are then made automatically. In the event of errors or for more information, see **"Configuration program options" on page 12**.

---

\* You can ascertain the Gigaset M105 Data's virtual COM port either by starting the program *Gigaset Setup* and reading the COM port in the *Connection* tab (it may take a few seconds until it is displayed correctly) or by selecting > *Start > Settings > Control Panel > System*, click the *Device Manager* tab and select the ports (COM and LPT). A list of the ports installed appears. You will recognise the virtual COM port of the Gigaset M105 Data from its name: *DECT USB serial Port (COM x)*.



## Registering Gigaset M105 Data at Gigaset M105 Data

### Proceed as follows:

1. Install Gigaset M105 Data.
2. Connect both Gigaset M105 Data units to a PC.
3. Start the Gigaset M105 Data configuration program via > Start > Programs > Gigaset M100 Data > Gigaset Setup.
4. Select the **Local adapter** tab at both PCs.
5. Change the M105 type at one of the PCs from "Portable part" to "Base" by clicking the **Change adapter type** button in the **Local adapter** tab and confirming the subsequent warning message with Yes. The adaptor type is now changed.
6. Click the **Register** button at both PCs.  
At the PC connected to the "Base" type Gigaset M105 Data, an LED flashes in sequence to signal that the unit is ready for registration. The configuration program is complete once you click OK to exit.  
Further configuration is now performed exclusively at the PC connected to the "Portable part" type Gigaset M105 Data. Enter the PIN at this PC. This is "0000" by default.
7. Click **OK**. The registration operation starts and the message **"If the required base is ready for registration, the local adapter logs on. Check that the base is ready for registration."** appears on the screen.  
  
The two devices are automatically synchronised. There is now an entry in the **Registered bases** list.
8. Give the local station a suitable name, e.g. "PC".
9. Select the **Remote adapter** tab and give this also a name, e.g. "PC 2".  
The registered portable part also appears in the window here.
10. It may be useful to switch the *operating mode* from **"AT commands (PC)"** to one of the other operating modes. This setting concerns the protocol on the serial interface, in particular the speed adjustment. For more information, see **"Setting the operating mode" on page 15**.
11. Close the program with **OK**.

In the event of errors or for further information, see **"Configuration program options" on page 12**.



## Registering Gigaset M105 Data at Gigaset M101 Data

### Proceed as follows:

1. If the M101 is not already in the default status, please ensure that the M101 is operating as a "Base". Please refer to the configuration program for the type display and the switch options.
2. Press and hold down the black button on the Gigaset M101 Data (Base). After approx. 10 seconds, the LEDs indicate that the system is ready for registration by flashing in sequence.
3. Start the **Set Gigaset** program at the PC connected to the Gigaset M105 Data unit.
4. Select the **Local adapter** tab. The type is "Portable part".
5. Click the **Register** button and enter the PIN.
6. Click **OK**. The registration procedure starts and the message **"If the required base is ready for registration, the local adapter logs on. Check that the base is ready for registration."** appears on the screen.  

The two devices are automatically synchronised. An entry now appears in the **Registered bases** list.
7. Assign a suitable name to the local adapter, e.g. "PC".
8. Open the **Remote adapter** tab and assign a name to it, e.g. "PC 2". The registered portable part now also appears in this window.
9. Select the operating mode tab and change the operating mode from AT commands (PC) to Direct connection. Make the following settings (example): Bits per second: 115200 - Databits: 8 - Parity: None (N) - Stop bits: 1 - Dataflow control: Hardware (RTS/CTS). For more information, see **"Setting the operating mode" on page 15**.
10. Close the program with **OK**.

In the event of errors or for further information, see **"Configuration program options" on page 12**.



# Configuration program options

## General

You will not need the majority of configuration options for the simple implementation of a Gigaset M105 Data unit downstream of a Gigaset 3070/3075.

## Starting the configuration program

Under **Start**, select **Programs** followed by **Gigaset M100 Data** and finally **Set Gigaset**.

The configuration program offers a dialog box entitled **Properties of Gigaset M101 Data** which contains the four tabs **Connect**, **Operating mode**, **Local adapter** und **Remote adapter**.

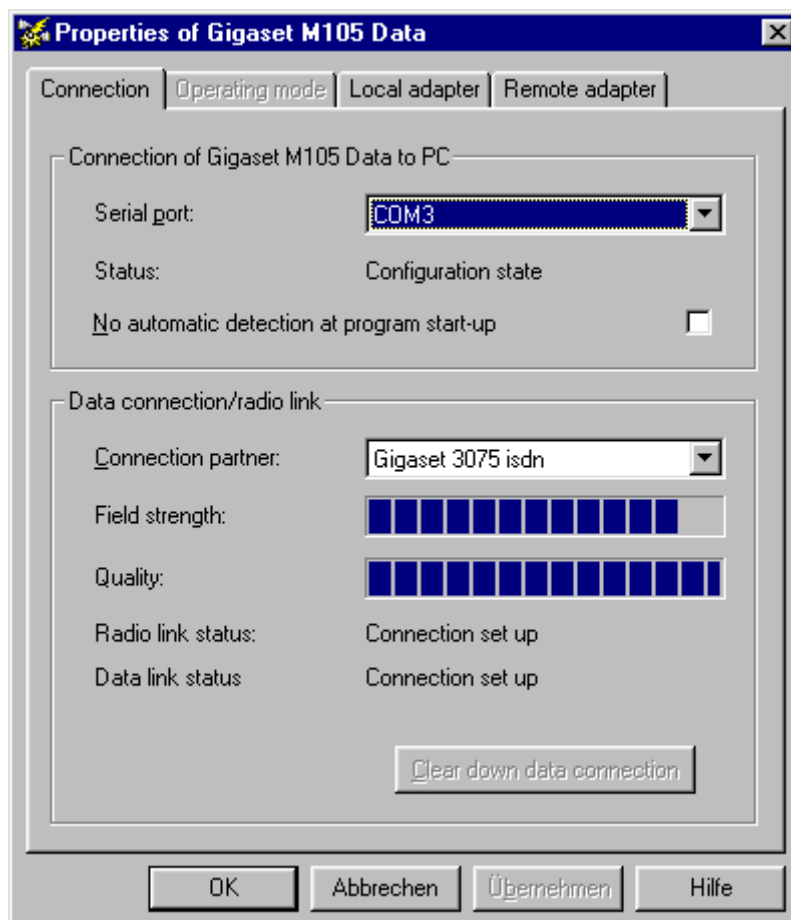

A number of special fields are also provided for special inputs.



## "Connection" tab

### Upper section: connecting to the PC

You can set the virtual COM port at which the local adapter is connected in the upper section of the tab.

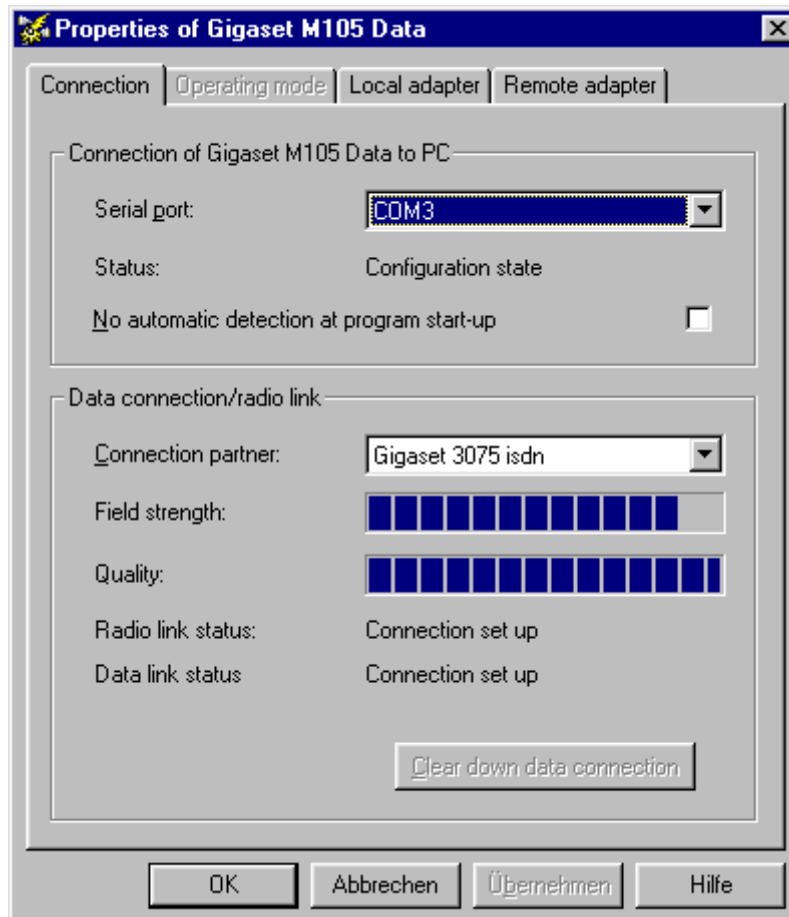

We recommend leaving the option **No automatic detection at program start-up** deactivated (as shown). The program then checks the existing COM ports and determines where the adapter is connected. Manual interface selection is only recommended if there is more than one Gigaset M105 Data unit connected to the PC. You can ascertain the Gigaset M105 Data's virtual COM port either by starting the program **Gigaset Setup** and reading the COM port in the **Connection** tab (it may take a few seconds until it is displayed correctly) or by selecting **> Start > Settings > Control Panel > System**, click the **Device Manager** tab and select the ports (COM and LPT). A list of the ports installed appears. You will recognise the virtual COM port of the Gigaset M105 Data from its name: **DECT USB serial Port (COM x)**.



As soon as the program finds an adapter or identifies the manually selected interface, it sends it the configuration command via the control lines. This action switches the adapter to configuration status. This is indicated by the **Status:** display in the dialog box. Gigaset M105 Data can only be configured under these conditions. Your Gigaset M105 Data will automatically switch the adapter back to operating status at the end of the program.

#### Lower section: DECT connection

This section indicates whether a radio connection exists and if so, to which Remote adapter. It also indicates the quality of the connection. A Remote adapter must be registered before it can be selected here.





## "Operating mode" tab

### Important:

The "Operating mode" tab is not active if the registered Remote adapter is a Gigaset 3070/75isdn. In this case, no settings can be made in this tab.

If one of the adapters is set to "AT commands (PC)" or "AVM compatible (PC)", the other adapter must switch to the corresponding operating mode "AT commands (device)" or "AVM compatible (device)". If one adapter is switched to "Direct connection", the other adapter must also be switched to this mode. The appropriate switches are performed automatically if you select an operating mode for a Gigaset M105 Data unit.

### Setting the operating mode

Open the **Operating mode** tab and select one of the five modes:

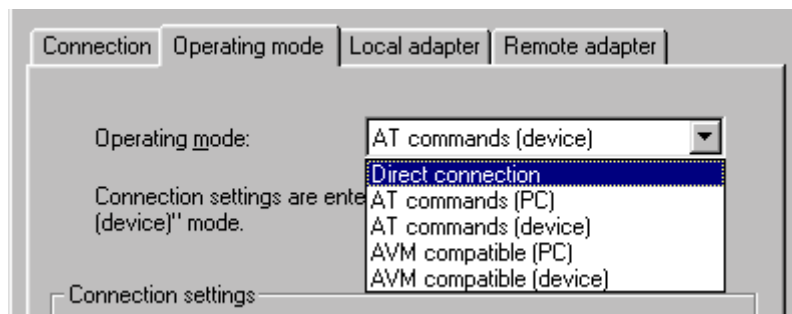

The three connection types are used for different purposes:

- Direct connection** The permanent transmission parameters for the virtual COM port are manually set at the computer without automatic baud rate or data format recognition. This is always useful if the device at the Remote adapter does not support baud rate or data format recognition as performed by conventional modems, e.g. in the case of a second PC.
- AT commands (PC)** Automatic recognition of the transmission parameters based on the data from the PC at the local adapter.
- AT commands (device)** Automatic emulation of the transmission parameters on the values received by the PC at the remote adapter.



**AVM compatible (PC)**

Automatic recognition of the transmission parameters of the data (AVM-compatible format) by the PC at the local adapter.

**AVM compatible (device)**

Automatic emulation of the transmission parameters on the values (AVM-compatible format) received by the PC at the remote station.

### Special features with Direct Connection

The transmission parameters are set manually as defaults on the computer for the COM port of the PC without automatic baud rate or data format recognition. This is always useful if the device at the remote adapter does not support automatic baud rate or data format recognition as performed by conventional modems, e.g. in the case of a second PC.



### Special settings for "Direct connection" mode

In Direct connection mode, the fields in the lower section of the dialog box are activated: you can set the transmission parameters for the virtual COM port at the PC.

Use the default settings if you do not want to change any other parameters. In the event of malfunctions, reduce the speed in the Bits per second field. Set your communication software likewise to this value.

In the case of changes, only permitted values are accepted in the individual fields, even for manual inputs.

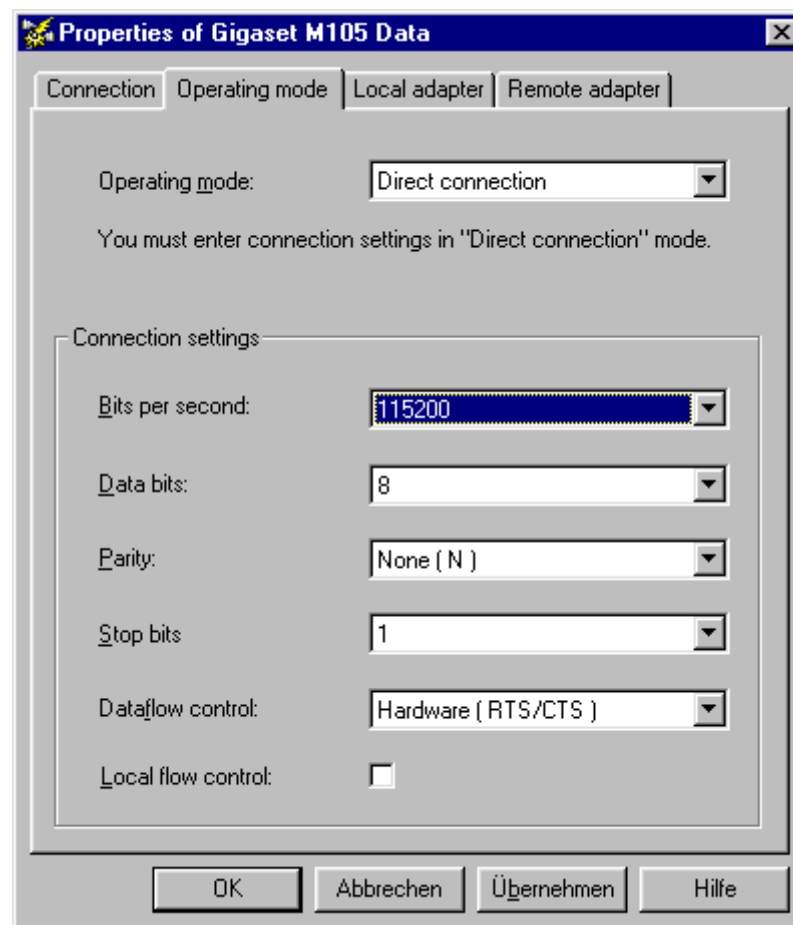

### Bit rate list

The speed at which your V.24 terminal (e.g. modem) or a second computer communicates with your computer is referred to as the bit rate and is always specified in bps (bits per second). Very often the terms baud rate and baud units are used incorrectly. You should specify the highest possible processor speed (port speed) supported by your modem.



### Data bits, Parity and Stop bits lists

Data bits, parity and stop bits are mutually dependent; very often the setting of a specific number of data bits will determine the parity and stop bits to be selected. The most usual settings are 8 data bits, no parity and 1 stop bit (often abbreviated to N81 or 8N1), or 7 data bits, even parity and 1 stop bit (E71 or 7E1).

If you do not have in-depth knowledge of serial communication you should not change these settings.

### Dataflow control list

You can set whether the data transmission is controlled by the hardware or software. The usual setting is *Hardware (RTS/CTS)*. RTS means "Request To Send" and CTS means "Clear To Send".

- **XON/XOFF dataflow control** is also referred to as software dataflow control because the dataflow is controlled in this case using special control characters (XON and XOFF), which are inserted into the dataflow that is sent.
- **CTS/RTS dataflow control** is also referred to as hardware dataflow control because certain electronic signals (CTS and RTS) are exchanged over special lines to control the dataflow.
- **DSR/DTR dataflow control** is also referred to as hardware dataflow control for direct connections because in this case certain electrical signals (DSR and DTR) are exchanged over special lines to control the dataflow.

If you do not have in-depth knowledge of serial communication you should not change these settings.



**fLocal flow control check box**

Local flow control normally does not have to be activated except when operating low-memory V.24 terminals (in connection with Gigaset M101 Data). Activating local flow control can help in the event of data transmission problems (e.g. sending faxes, operating a serial printer).

When local flow control is active, the Gigaset M105 Data unit connected to the V.24 terminal immediately stops outputting data in the direction of the terminal when a STOP signal is received and saves this data in its own memory. This ensures that the PC only sends data that can be processed by the transmission route (saved). If local flow control is not activated, the V.24 terminal's STOP signal is transferred to the PC. During this time (less than 10 ms), the PC continues to send data. All of this data is output by the Gigaset M101 Data unit in the direction of the V.24 terminal. If the terminal does not have sufficient memory to receive this data, the data is lost.

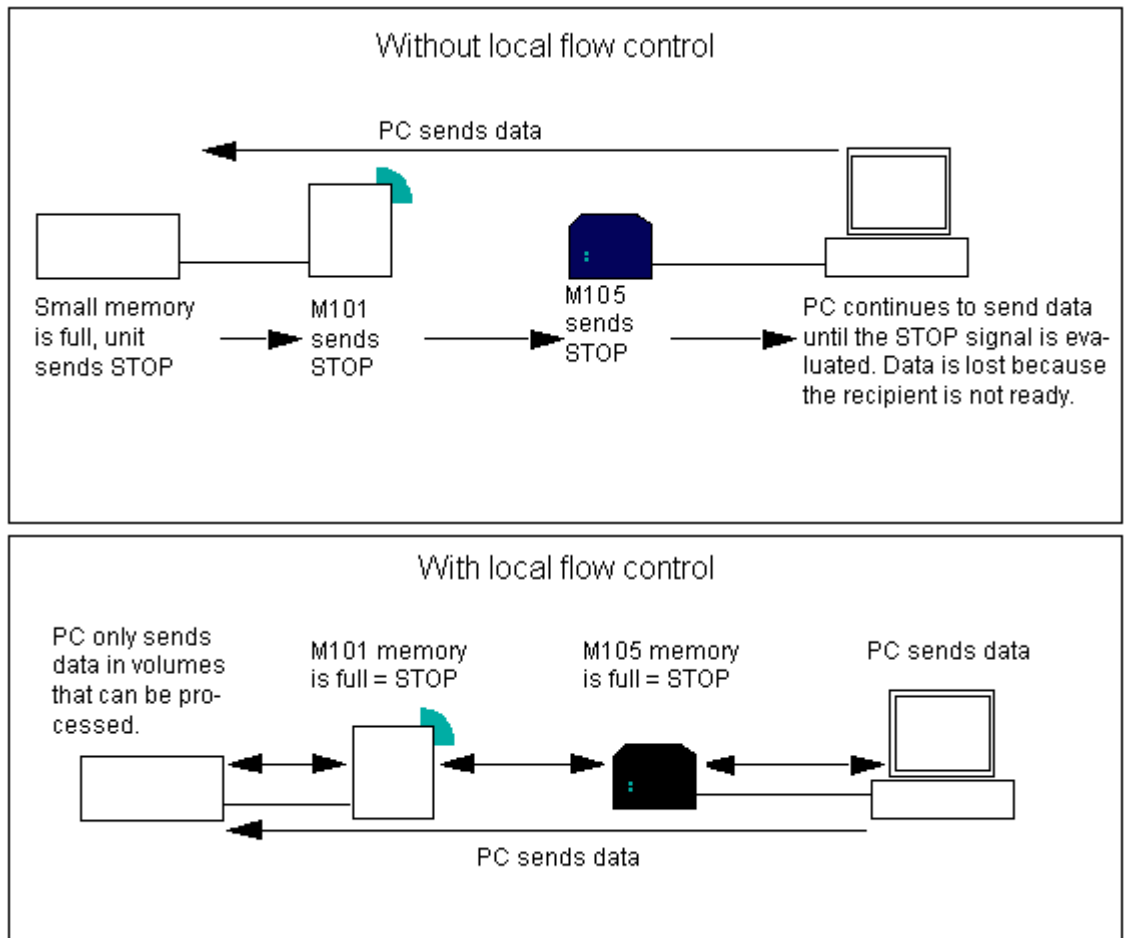

## "Local adapter" tab

### Changing the name

The purpose of adapter names is to provide a rapid overview. The local adapter must be called "PC". The remote adapters should, if possible, be named after the peripheral device connected, e.g. "3070/3075isdn" or "Modem".

Adapter names can be changed by entering or changing a name in the Name field. Names can contain letters and digits as well as blanks. The name must not contain more than 20 characters.

### Change adapter type

Normally, a portable part is operated at the PC and the base station is operated at the peripheral device. Other constellations, however, are possible in which both adapters are connected to a PC in order, for example, to create a cordless data connection between two PCs. In this case, the adapter type of one of Gigaset M105 Data units must be **Base** while the adapter type of the other must be a **Base**. Or you can implement more than one remote adapter in order to control a second PC or the modem alternately. It may also be necessary here to change the adapter type at one of the Gigaset M105 Data units.

- Ensure that the correct Gigaset M105 Data is connected at the PC.
- Select **Change adapter type**. The change is performed in the background. You can see that it has been performed when the information in the **Adapter type:** line changes.

### Change PIN ...

See Change PIN ... on page 20



### Registering a portable part

Both adapters are powered. The Gigaset M105 Data unit is connected to the PC; start the "Set Gigaset" program.

Select the **Local adapter** tab.

The following dialog box appears:

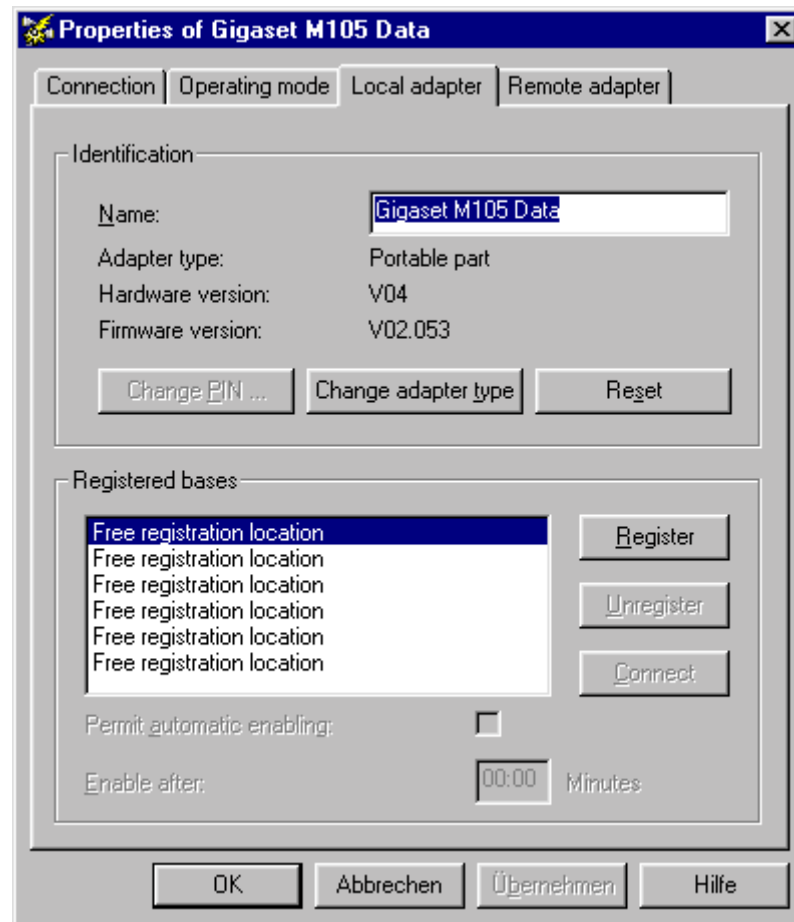

Up to six registered devices can be entered in the **Registered adapter** window. Depending on the adapter type of the local adapter, **Registered adapter** or **Registered bases** is displayed.



Select a registration location and click **Register**.

The following window appears :

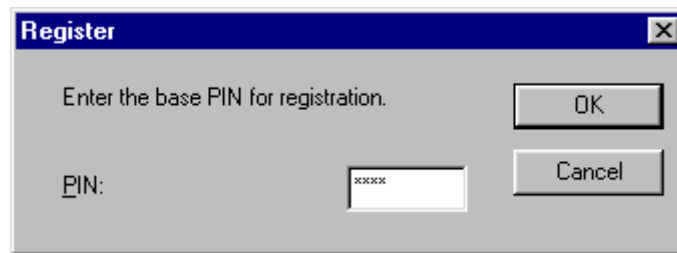

Enter the PIN (PIN: 1-8 digits, default 0000) and click **OK**.

The portable part now searches for the base station and automatically registers at it.

If registration is not possible (base station not in registration mode or not powered, incorrect PIN), the system will indicate the necessary steps for resolving this problem.

### De-registering a portable part

Select the adapter in the window and click **Unregister**.

### Automatic enabling

The automatic enabling feature is not available with Gigaset3070/75isdn. The data connection is automatically enabled as soon as usage stops. The "**Permit automatic enabling:**" feature eliminates the need to enable the data connection manually. If the V.24 interface is not used for a set length of time (no activity on the V.24 interface and control line DTR = 0), then this is automatically enabled and can be automatically seized by another portable part. See "Remote adapter" tab on page 23.

If you permit automatic enabling, you must also define an enabling time.

### Manual enabling

See "Remote adapter" tab on page 23





### "Remote adapter" tab

This tab is used for configuring the Remote adapter that is not connected to the PC. Registration must be performed first so that the two Gigaset M105 Data units can communicate.

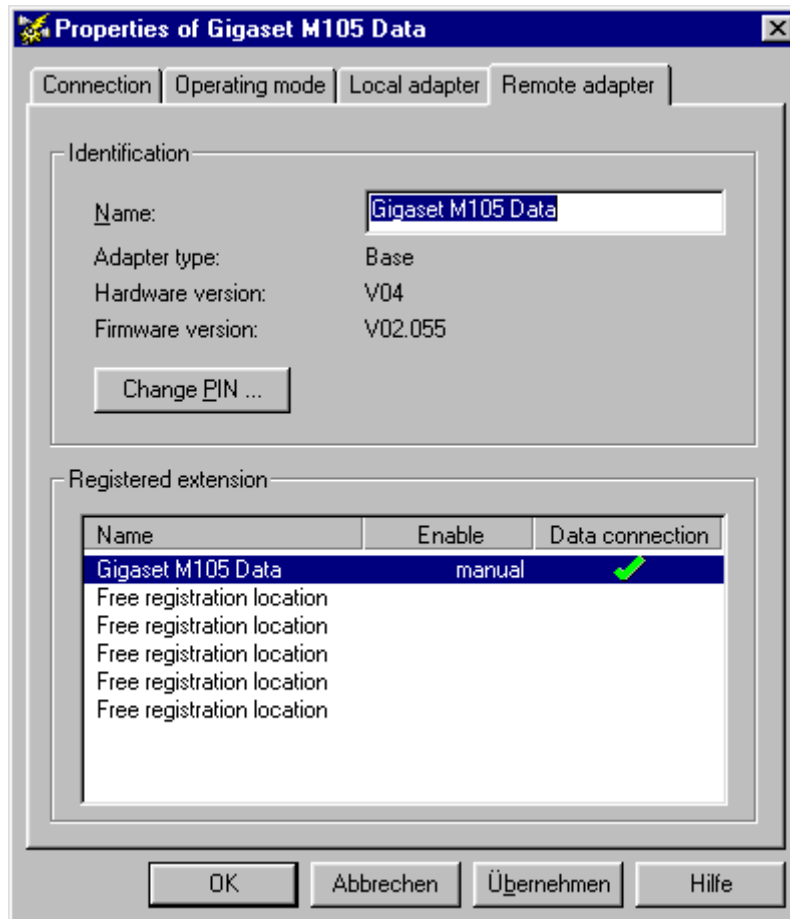

 The **Remote adapter** tab is only available after registration on the **Local adapter** tab.



## Changing the name

As for local adapter, *see "Changing the name" on page 20.*

## Change PIN

Click **Change PIN**.

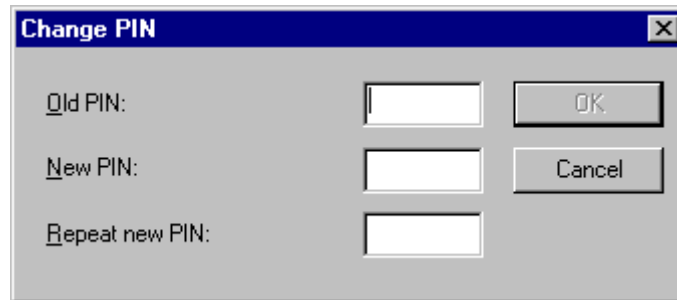

Enter the old PIN (PIN: 1–8 digits, default: 0000) to obtain authorisation to change the PIN and press the tab key.

Enter the new PIN and press the tab key.

Enter the new PIN in the Repeat new PIN field and click **OK**.

The PIN is changed if the new PINs entered are identical and if the correct old PIN is entered. Otherwise, a warning appears.

The PIN of the Gigaset3070/75isdn unit **cannot** be changed as described.



### LEDs

There are two LEDs on the front of the Gigaset M105 Data unit.



### LED 1: Gigaset M105 Data status

LED 1 indicates stand-by mode:

LED 1 flashes slowly

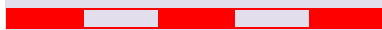

The adapter is searching for the partner or has not been registered.

LED 1 flashes quickly



The partner was found, the data connection is not assigned to the transmission route.

LED 1 is constantly lit



The partner was found, the transmission route is on stand-by.

### LED 2: data transfer

LED 2 indicates the status of the transmission route of the interface:

LED 2 off

No data transfer

LED 2 flickers/is lit

Data transfer active



## Notes on installation and operation

### Place of installation

There must be a 220/230 V AC and 50 Hz power socket nearby.

The Gigaset M105 Data should not be installed in the immediate vicinity of other electronic devices, such as hi-fi systems, office equipment or microwave ovens, otherwise there is a risk of mutual interference.

Place the Gigaset M105 Data unit on a level, non-slip surface. The device feet do not leave any unsightly marks. However, in view of the many different varnishes and polishes currently used for furniture, the possibility of marks being left cannot be ruled out.

Radio communication between **Base** and **Portable part** is based on the DECT standard. The Gigaset M105 Data complies fully with the relevant European directives. Should you nevertheless experience sound or picture distortion with your satellite signal receiving equipment, please get in touch with your dealer to have it tested for shielding faults.

Depending on the ambient conditions, the maximum range for a radio connection between the local adapter and the Remote adapter is approx. 300 m outdoors and approx. 50 m indoors.

### Temperature and ambient conditions

Gigaset M105 Data is designed for operation in protected rooms with a temperature range from +5 °C to +45 °C and 20 % to 75 % relative humidity.

Do not install the Gigaset M105 Data unit in damp environments, such as a bathroom or laundry room. Do not expose it to direct sunlight or other heat sources, such as radiators.

When passing on the Gigaset M105 Data to third parties you should always include the booklet and the CD-ROM.



## Why set an operating mode? Technical background

Configuration is always performed for both data modules on connection link. In the case of registration at a Gigaset 3070/3075isdn, the transmission parameters are set automatically; apart from the assignment of a name, no other settings are necessary.

## Special features when connecting two Gigaset M105 or M101 Data units

A Gigaset M105 Data unit is powered via the USB port but operates like a COM interface with regard to data. For this reason, the transmission rate is also provided. **The USB bus cable cannot be extended!** When a Gigaset M105 Data is connected to a Gigaset M101 Data, the firmware version of the Gigaset M101 Data must be V2.0. This firmware can be downloaded free of charge from the Internet site <http://www.siemens.com/gigaset>.

→ see "Access to different V.24 terminals from a laptop:" on page 29.

→ see "Sequential access from multiple computers to a terminal:" on page 30.

## Notes on the COM interface

Serial interfaces are more than connectors. They have an integrated dataflow control, control lines, data lines and an adjustable speed function. Serial interface are used to transport data in various formats.

Modems are usually controlled with AT commands or proprietary protocols that they receive via their serial interface. On the basis of these commands, modems can recognise the data format and speed at which the data is transferred. The automatic recognition of transmission parameters is important and must be emulated by the radio link if a device that understands the AT or AVM-compatible commands and that is used for parameter synchronisation is connected to the remote adapter.

A cordless extension cable between a PC and, for example, a modem must detect the transmission parameters to be used at the PC interface for communication between this interface and the modem. On the modem side, the functions generated by the PC must also be created for the serial interface.

On the radio link, data is transmitted according to a radio protocol that has nothing to do with the serial interface.

If a device which cannot detect transmission parameters in the same way as a modem is connected to the remote adapter, "Direct connection" is selected as the operating mode.



There are **five** possible operating modes for every Gigaset M101/M105 Data:

1. **Direct connection:** this operating mode is implemented for all devices that are not controlled with AT or AVM-compatible commands
2. **AT commands (PC) or AVM compatible (PC):** this is the operating mode for the local adapter. The Gigaset M105 Data unit determines the conditions on the serial interface in the same way as a modem. In addition to the data, the transmission parameters are also transmitted to the Remote adapter which then transfers the data to the connected device.
3. **AT commands (device) or AVM compatible (device):** in this operating mode, the remote adapter controls a terminal that understands AT commands.

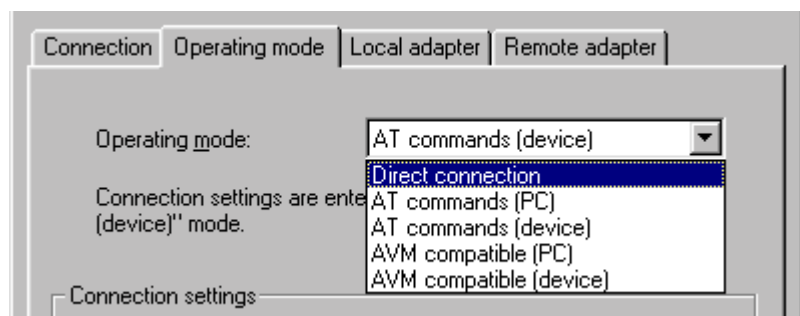

## Tips&tricks, settings

This section describes settings, implementation options and programming methods.

### Access to different V.24 terminals from a laptop:

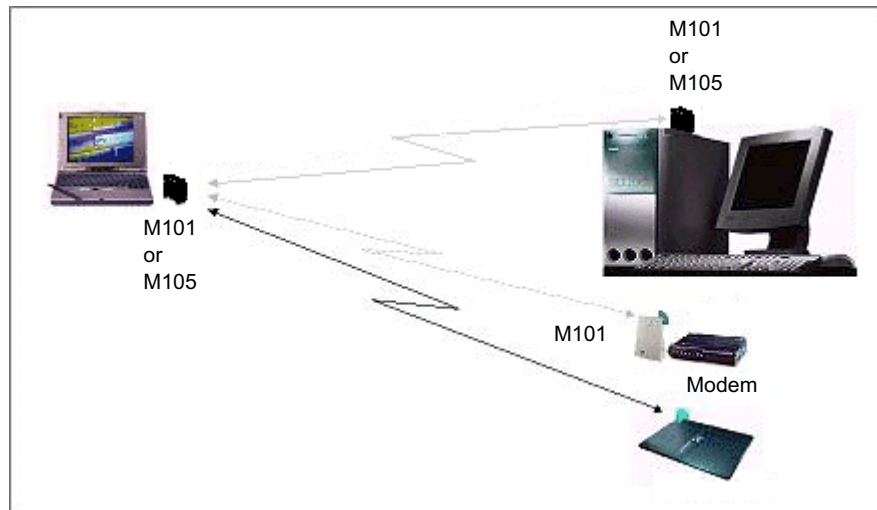

- All terminals (PC, modem, Gigaset 3070/3075isdn) can be accessed from a laptop.
- Only one data connection at a time can ever be set up to a terminal.
- You must select the relevant connection partner in the configuration mask in order to switch between the various terminals. This can be done in the **Connection partner:** list in the **Connection** tab (→ page 13) and via the **Connect** button in the **Local adapter** tab (→ page 20).
- If Gigaset 3070/3075isdn, for example, is selected as the connection partner, then an incoming call at the modem, for example, cannot be signalled at the laptop. This is not resolved by "Permit automatic enabling:" feature (→ page 22).



## Sequential access from multiple computers to a terminal:

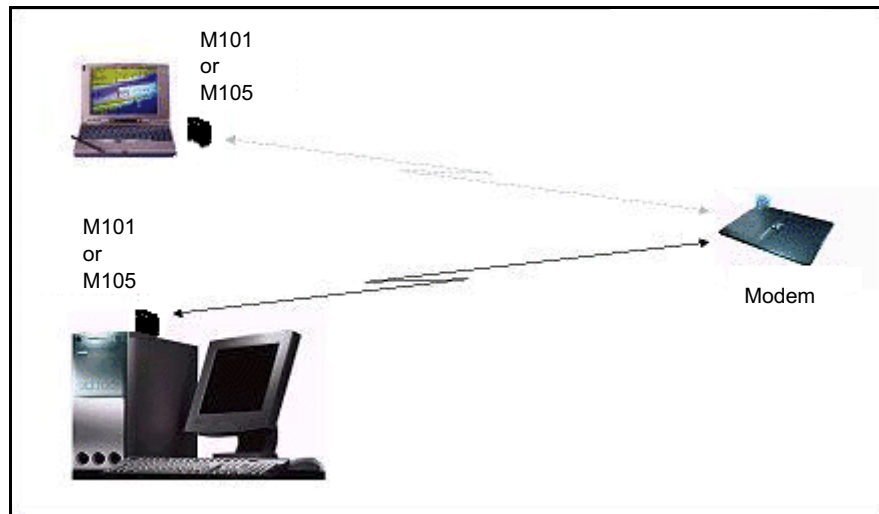

- Multiple portable parts (PC, laptop) share a Gigaset 3070/3075isdn base (modem).
- Only one data connection at a time can ever be set up from a "portable part to the terminal".
- Simultaneous access from both portable parts to the Gigaset 3070/3075isdn modem is not possible.
- The data connection is automatically enabled if the data line is not accessed.





## What happens if...

If a malfunction occurs, check the following points:

- The USB cable connections to the connected devices are fully inserted.
- The adapters are not too far apart and there are no large parts of buildings in between (see "*Place of installation*" on page 26).
- Registration was successful.

When operating Gigaset 105 Data with Gigaset 101 Data:

- The local adapter operating mode is set to **AT commands (PC)** or **AVM compatible (PC)**.

**Or:**

- The local adapter operating mode is set to **Direct connection** *and* you have set the direct connection transmission parameters in your communication software.

If the malfunction persists after checking all the above points, call the hotline at +353 18 50 77 72 77.

Siemens Service should only be contacted if problems develop with the device. Your specialist dealer will be happy to answer any questions concerning unit operation. Contact your network operator/provider for questions concerning telephone connection.

**Internet:** [www.siemens.com/gigaset](http://www.siemens.com/gigaset)



## Support

### Updates and news on the Internet

Internet: [www.siemens.com/gigaset](http://www.siemens.com/gigaset)

### Notes on sending faxes directly from the PC

You may encounter problems if your PC program uses Class 1 fax mode. Class 1 does not support signal runtime delays which are required for switching to radio mode.

Class 2 mode, on the other hand is less sensitive. Nevertheless, interference can still occur here due to a bad radio link. If you have problems with this setting, start the configuration program and check the transmission quality under **Connection** and improve the quality of the connection by moving the Gigaset M105 Data unit slightly.

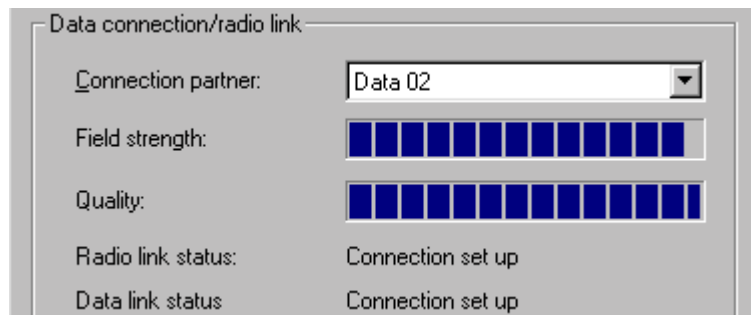

## Configuration management

Fault	Cause	Solution
Message from configuration program: "Data adapter not found..."	The COM port used is being used by another program.	Close the application that is using the COM port.
Message from configuration program: Registration not possible.	The base station may not have been ready for registration or the radio connection was temporarily affected by "external influences".	Repeat registration with a base that is ready. The PIN must be entered for this (factory setting: "0000"). See <b>"Registering a portable part" on page 21.</b>
PIN entered is rejected	The PIN entered does not match the valid PIN.	If you forgot the current PIN, reset the Gigaset M105 Data unit to the factory defaults. The preset PIN is "0000".

## Problems with application programs

Fault	Cause	Solution
Fax function is not working.	SW and modem simulate a Class1 fax.	Class 1 fax mode is not supported by Gigaset M105 Data for technical reasons. Gigaset M105 Data supports Class 2 fax mode.
	Find out about additional settings in the modem manual or description of your fax software. (The AT command AT+FCLASS=? is useful, provided this is supported by the modem. If the modem's answer string contains a 2, then your modem supports Class 2 fax mode).	
Programs that use DCD (Data Carrierer Detect) are not working properly.	The DCD output at the local adapter is controlled by the DCD input at the remote adapter.	Use a null-modem cable at the remote adapter.



Fault	Cause	Solution
The modem parameter request function is not working or is not correct. For example, under Win 98 with <Start><Settings><Control Panel><Modems><Diagnostics><More Info>	Windows does not follow the AT Hayes conditions.	None
	Technically specified time delay that are not supported by the modem's driver software.	None
Data transmission with Xmodem is very slow.	Xmodem operates in half-duplex mode. The transmitting unit waits for acknowledgement after each data package. The signal delay (20–30 ms per data block at the DECT interface) significantly reduces the transmission speed.	Use another transmission protocol, e.g. Zmodem.
Laplink 7.0 is not working.	Data transmission is switched during transmission, AT Hayes commands are not used for this.	None

### Miscellaneous

Fault	Cause	Solution
Monitor fault when Gigaset M105 Data is active (e.g. slight flickering or moiré effect).	DECT HF wanted signals is influencing the monitor.	Move Gigaset M105 Data along the longitudinal axis until the interference disappears. Move Gigaset M105 Data further away from the monitor.
A slight humming can be heard in the loudspeakers connected to the sound card when Gigaset M105 Data is active.	DECT HF wanted signal is demodulated by the analog components of the sound card or the amplifiers of the active speakers and thus produces a humming sound.	Move Gigaset M105 Data along the longitudinal axis until the interference disappears. Move Gigaset M105 Data further away from the sound card/loudspeakers.



## Technical data

Standard:	DECT =Digital Enhanced Cordless Telecommunications
Number of channels:	120 duplex channels
Radio frequency range:	1880 MHz to 1900 MHz
Transmitted power:	10 mW, average rating per channel
Range:	up to 300 m outdoors, up to 50 m indoors
Power supply:	USB powered
Power consumption:	Stand-by mode: approx. 4 W Data transfer mode: approx. 5 W
Permissible ambient conditions for operation:	+5 °C to +45 °C 20 % to 75 % relative humidity
USB port:	Type B socket
Standards complied with:	DECT in accordance with CTR 6 Electrical safety in accordance with EN 60950



## Safety precautions



Medical equipment can be affected by DECT devices.

Gigaset M105 Data can cause unpleasant humming in hearing aids.

Do not install Gigaset M105 Data in bathrooms or showers.

Do not operate Gigaset M105 Data in environments where there is risk of explosion.

Do not forget to include the operating instructions and CD when passing on Gigaset M105 Data to a third party.

Gigaset M105 Data is designed for operation in your country as indicated on the back of the unit. Special country-specific features have been implemented. Your specialist dealer or network provider will be happy to answer any questions with regard to differences in public telephone networks.

The compliance of the unit with the basic R&TTE requirements of the terminal directive is certified by the CE symbol.

We, Siemens AG, declare, that the above mentioned product is manufactured according to our Full Quality Assurance System certified by CETECOM ICT Services GmbH with the registration number "Q810820M" in compliance with ANNEX V of the R&TTE-Directive 99/05/EC. The presumption of conformity with the essential requirements regarding Council Directive 99/05/EC is ensured.

Senior Approvals Manager

CE 0682



# Index

## Numerics

3070isdn/3075isdn 8

## A

Adapter type, changing 20  
Ambient conditions 26  
AT commands 15  
AT commands or AVM compatible 28  
Automatic enabling 22

## B

Base 5  
Bit rate 17

## C

Changing the name 20  
Class 2 fax operation 33  
Clear To Send 18  
COM port, setting 13  
Configuration program  
starting 12  
Connection 13

## D

Data adapter not found 33  
Data bits 18  
Data transfer LED 25  
Dataflow control 18  
DCD programs do not operate properly 33  
DECT 35  
DECT connection 14  
Direct connection 15, 17, 28  
Download 27

## E

Enabling time 22

## F

Fax function does not work 33  
Flow control 19

## H

Hardware (RTS/CTS) 18

## I

Implementation options 29  
Initial configuration 8  
Installation 5

## L

Laplink 7.0 34  
Laptop 29  
LEDs 25  
Local adapter 4, 20  
Local flow control 19  
Loudspeaker hums slightly 34

## M

Memory 5  
Modem 29  
Monitor flickers slightly 34  
Multilink operation 5

## N

Notes on the COM interface 27

## O

Operating mode 15, 27  
Operating mode, setting 15  
Operating systems 5

## P

Parity 18  
PC 29  
PIN rejected 33  
PIN, changing 24  
Place of installation 26  
Portable part 5  
Program, installing 5



## R

- Registering at 3070isdn/3075isdn **8**
- Registering at Gigaset M101 Data **11**
- Registering at Gigaset M105 Data **10**
- Registration not possible **33**
- Remote adapter **4, 23**
  - de-registering **22, 23**
  - registering **21**
- Request To Send **18**

## S

- Special features **27**
- Status LED **25**
- Stop bits **18**

## T

- Tab
  - Connection **13**
  - Local adapter **20**
  - Operating mode **15**
  - Remote adapter **23**
- Tips **29**

## U

- USB bus cable and M105 **4, 27**

## W

- What happens if... **31**

## X

- Xmodem **34**

